

2N7002K, 2V7002K

Small Signal MOSFET

60 V, 380 mA, Single, N-Channel, SOT-23

Features

- ESD Protected
- Low $R_{DS(on)}$
- Surface Mount Package
- 2V Prefix for Automotive and Other Applications Requiring Unique Site and Control Change Requirements; AEC-Q101 Qualified and PPAP Capable
- These Devices are Pb-Free, Halogen Free/BFR Free and are RoHS Compliant

Applications

- Low Side Load Switch
- Level Shift Circuits
- DC-DC Converter
- Portable Applications i.e. DSC, PDA, Cell Phone, etc.

MAXIMUM RATINGS ($T_J = 25^\circ\text{C}$ unless otherwise stated)

| Rating | Symbol | Value | Unit |
|---------------------------------------------------------------------------|----------------|---------------------------------|------------------|
| Drain-to-Source Voltage | V_{DS} | 60 | V |
| Gate-to-Source Voltage | V_{GS} | ± 20 | V |
| Drain Current (Note 1) Steady State 1 sq in Pad | I_D | $T_A = 25^\circ\text{C}$ 380 | mA |
| | | $T_A = 85^\circ\text{C}$ 270 | |
| Drain Current (Note 2) Steady State Minimum Pad | I_D | $T_A = 25^\circ\text{C}$ 320 | mA |
| | | $T_A = 85^\circ\text{C}$ 230 | |
| Power Dissipation Steady State 1 sq in Pad Steady State Minimum Pad | P_D | 420 | mW |
| | | 300 | |
| Pulsed Drain Current ($t_p = 10 \mu\text{s}$) | I_{DM} | 5.0 | A |
| Operating Junction and Storage Temperature Range | T_J, T_{STG} | -55 to +150 | $^\circ\text{C}$ |
| Source Current (Body Diode) | I_S | 300 | mA |
| Lead Temperature for Soldering Purposes (1/8" from case for 10 s) | T_L | 260 | $^\circ\text{C}$ |
| Gate-Source ESD Rating (HBM, Method 3015) | ESD | 2000 | V |

Stresses exceeding those listed in the Maximum Ratings table may damage the device. If any of these limits are exceeded, device functionality should not be assumed, damage may occur and reliability may be affected.

1. Surface-mounted on FR4 board using 1 sq in pad size with 1 oz Cu.
2. Surface-mounted on FR4 board using 0.08 sq in pad size with 1 oz Cu.



ON Semiconductor®

www.onsemi.com

| $V_{(BR)DSS}$ | $R_{DS(on)}$ MAX | I_D MAX |
|---------------|----------------------|-----------|
| 60 V | 1.6 Ω @ 10 V | 380 mA |
| | 2.5 Ω @ 4.5 V | |

SIMPLIFIED SCHEMATIC

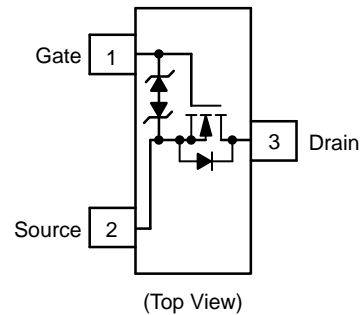

MARKING DIAGRAM & PIN ASSIGNMENT

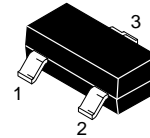

SOT-23
CASE 318
STYLE 21

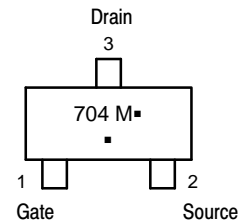

- 704 = Specific Device Code*
- M = Date Code*
- = Pb-Free Package

(Note: Microdot may be in either location)
*Specific Device Code, Date Code or overbar orientation and/or location may vary depending upon manufacturing location. This is a representation only and actual devices may not match this drawing exactly.

ORDERING INFORMATION

| Device | Package | Shipping† |
|------------|---------------------|--------------------|
| 2N7002KT1G | SOT-23 (Pb-Free) | 3000 / Tape & Reel |
| 2V7002KT1G | SOT-23 (Pb-Free) | 3000 / Tape & Reel |

†For information on tape and reel specifications, including part orientation and tape sizes, please refer to our Tape and Reel Packaging Specifications Brochure, BRD8011/D.

2N7002K, 2V7002K

THERMAL CHARACTERISTICS

| Characteristic | Symbol | Max | Unit |
|---------------------------------------------|-----------------|-----|------|
| Junction-to-Ambient – Steady State (Note 3) | $R_{\theta JA}$ | 300 | °C/W |
| Junction-to-Ambient – $t \leq 5$ s (Note 3) | | 92 | |
| Junction-to-Ambient – Steady State (Note 4) | | 417 | |
| Junction-to-Ambient – $t \leq 5$ s (Note 4) | | 154 | |

3. Surface-mounted on FR4 board using 1 sq in pad size with 1 oz Cu.

4. Surface-mounted on FR4 board using 0.08 sq in pad size with 1 oz Cu.

ELECTRICAL CHARACTERISTICS ($T_J = 25^\circ\text{C}$ unless otherwise specified)

| Parameter | Symbol | Test Condition | Min | Typ | Max | Unit |
|-----------|--------|----------------|-----|-----|-----|------|
|-----------|--------|----------------|-----|-----|-----|------|

OFF CHARACTERISTICS

| | | | | | | |
|-----------------------------------------------------------|-------------------|-------------------------------------|---------------------------|----|----------|---------|
| Drain-to-Source Breakdown Voltage | $V_{(BR)DSS}$ | $V_{GS} = 0$ V, $I_D = 250$ μ A | 60 | | | V |
| Drain-to-Source Breakdown Voltage Temperature Coefficient | $V_{(BR)DSS}/T_J$ | | | 71 | | mV/°C |
| Zero Gate Voltage Drain Current | I_{DSS} | $V_{GS} = 0$ V, $V_{DS} = 60$ V | $T_J = 25^\circ\text{C}$ | | 1 | μ A |
| | | | $T_J = 125^\circ\text{C}$ | | 10 | |
| Gate-to-Source Leakage Current | I_{GSS} | $V_{DS} = 0$ V, $V_{GS} = \pm 20$ V | | | ± 10 | μ A |
| | | | | | 450 | nA |
| | | | | | 150 | nA |

ON CHARACTERISTICS (Note 5)

| | | | | | | |
|--------------------------------------------|------------------|-----------------------------------------|----------------------------------|------|------|----------|
| Gate Threshold Voltage | $V_{GS(TH)}$ | $V_{GS} = V_{DS}$, $I_D = 250$ μ A | 1.0 | | 2.3 | V |
| Negative Threshold Temperature Coefficient | $V_{GS(TH)}/T_J$ | | | 4.0 | | mV/°C |
| Drain-to-Source On Resistance | $R_{DS(on)}$ | $V_{GS} = 10$ V, $I_D = 500$ mA | | 1.19 | 1.6 | Ω |
| | | | $V_{GS} = 4.5$ V, $I_D = 200$ mA | | 1.33 | |
| Forward Transconductance | g_{FS} | $V_{DS} = 5$ V, $I_D = 200$ mA | | 530 | | mS |

CHARGES AND CAPACITANCES

| | | | | | | |
|------------------------------|--------------|---------------------------------------------------|--|------|-----|---------|
| Input Capacitance | C_{ISS} | $V_{GS} = 0$ V, $f = 1$ MHz, $V_{DS} = 20$ V | | 24.5 | 45 | μ F |
| Output Capacitance | C_{OSS} | | | 4.2 | 8.0 | |
| Reverse Transfer Capacitance | C_{RSS} | | | 2.2 | 5.0 | |
| Total Gate Charge | $Q_{G(TOT)}$ | $V_{GS} = 4.5$ V, $V_{DS} = 10$ V; $I_D = 200$ mA | | 0.7 | | nC |
| Threshold Gate Charge | $Q_{G(TH)}$ | | | 0.1 | | |
| Gate-to-Source Charge | Q_{GS} | | | 0.3 | | |
| Gate-to-Drain Charge | Q_{GD} | | | 0.1 | | |

SWITCHING CHARACTERISTICS, $V_{GS} = V$ (Note 6)

| | | | | | | |
|---------------------|--------------|-----------------------------------------------------------------------|--|------|--|----|
| Turn-On Delay Time | $t_{d(ON)}$ | $V_{GS} = 10$ V, $V_{DD} = 25$ V, $I_D = 500$ mA, $R_G = 25$ Ω | | 12.2 | | ns |
| Rise Time | t_r | | | 9.0 | | |
| Turn-Off Delay Time | $t_{d(OFF)}$ | | | 55.8 | | |
| Fall Time | t_f | | | 29 | | |

DRAIN-SOURCE DIODE CHARACTERISTICS

| | | | | | | | |
|-----------------------|----------|--------------------------------|--------------------------|--|-----|-----|---|
| Forward Diode Voltage | V_{SD} | $V_{GS} = 0$ V, $I_S = 200$ mA | $T_J = 25^\circ\text{C}$ | | 0.8 | 1.2 | V |
| | | | $T_J = 85^\circ\text{C}$ | | 0.7 | | |

Product parametric performance is indicated in the Electrical Characteristics for the listed test conditions, unless otherwise noted. Product performance may not be indicated by the Electrical Characteristics if operated under different conditions.

5. Pulse Test: pulse width ≤ 300 μ s, duty cycle $\leq 2\%$

6. Switching characteristics are independent of operating junction temperatures

TYPICAL CHARACTERISTICS

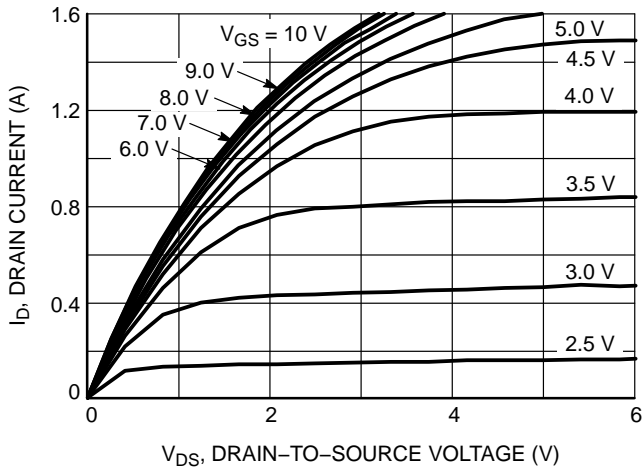

Figure 1. On-Region Characteristics

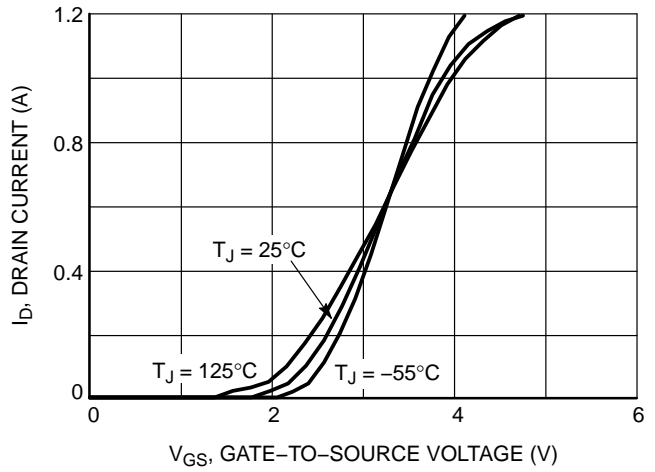

Figure 2. Transfer Characteristics

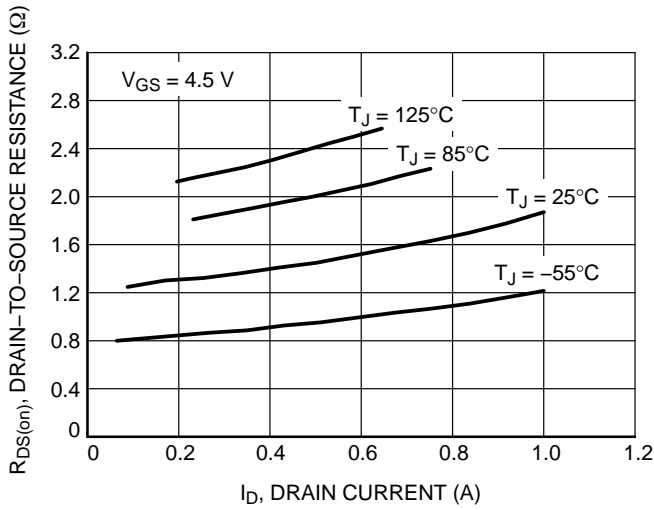

Figure 3. On-Resistance vs. Drain Current and Temperature

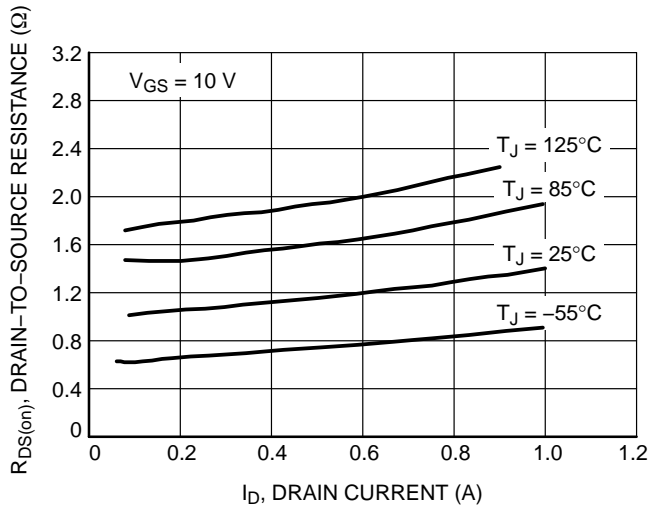

Figure 4. On-Resistance vs. Drain Current and Temperature

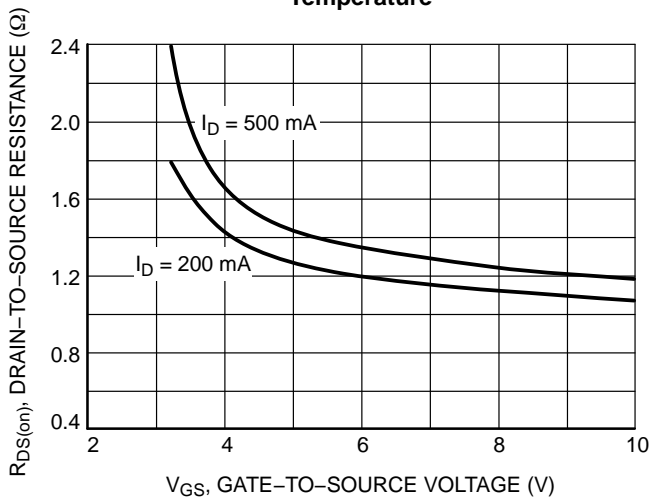

Figure 5. On-Resistance vs. Gate-to-Source Voltage

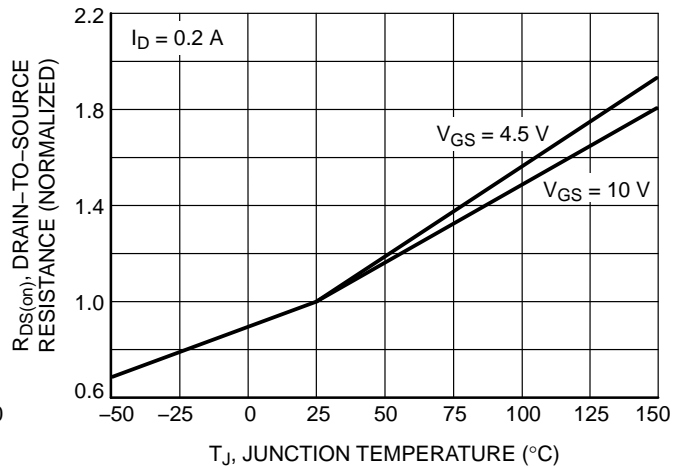

Figure 6. On-Resistance Variation with Temperature

2N7002K, 2V7002K

TYPICAL CHARACTERISTICS

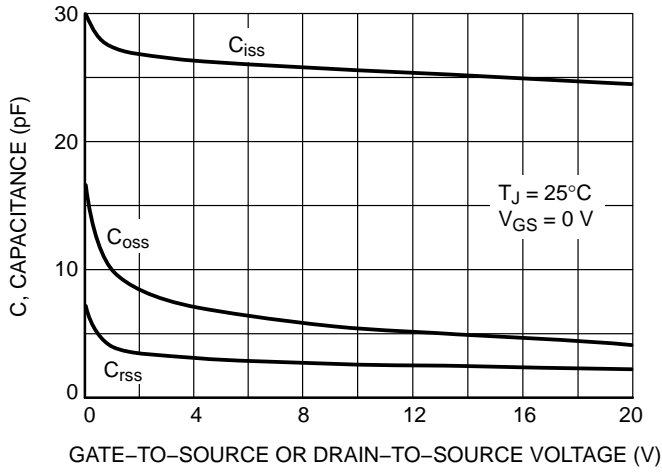

Figure 7. Capacitance Variation

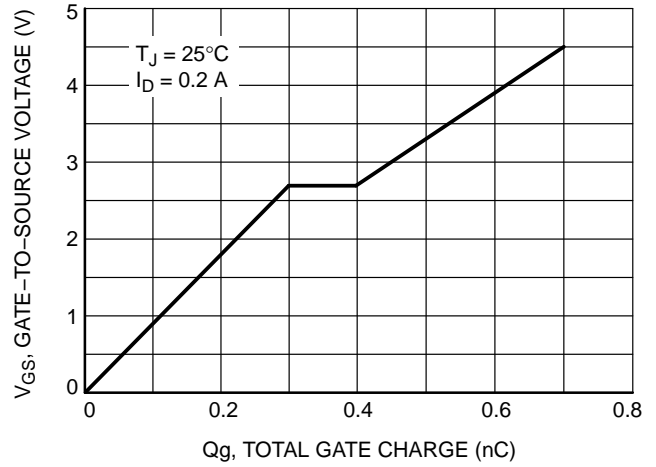

Figure 8. Gate-to-Source and Drain-to-Source Voltage vs. Total Charge

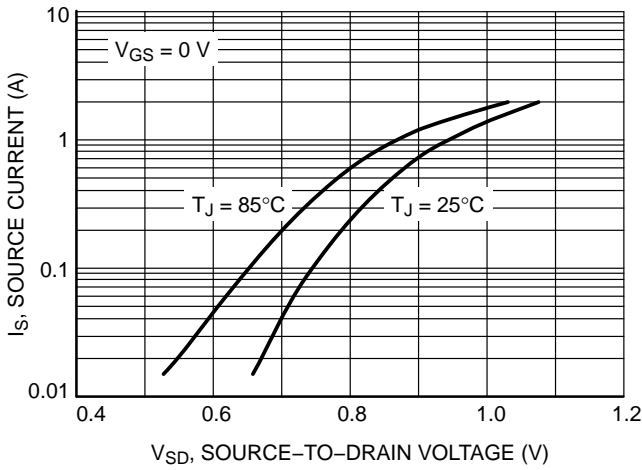

Figure 9. Diode Forward Voltage vs. Current

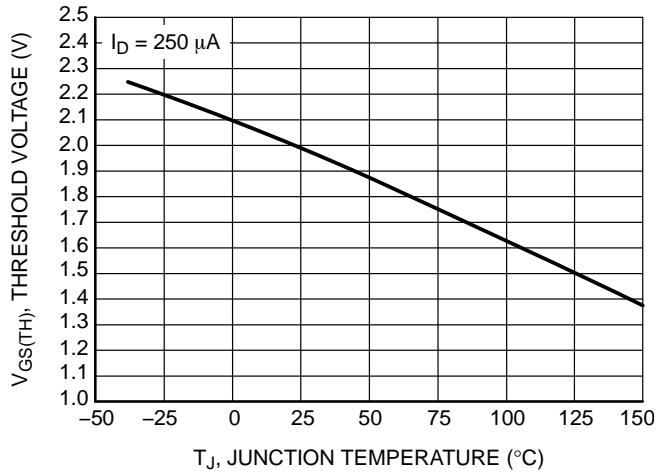

Figure 10. Threshold Voltage with Temperature

2N7002K, 2V7002K

TYPICAL CHARACTERISTICS

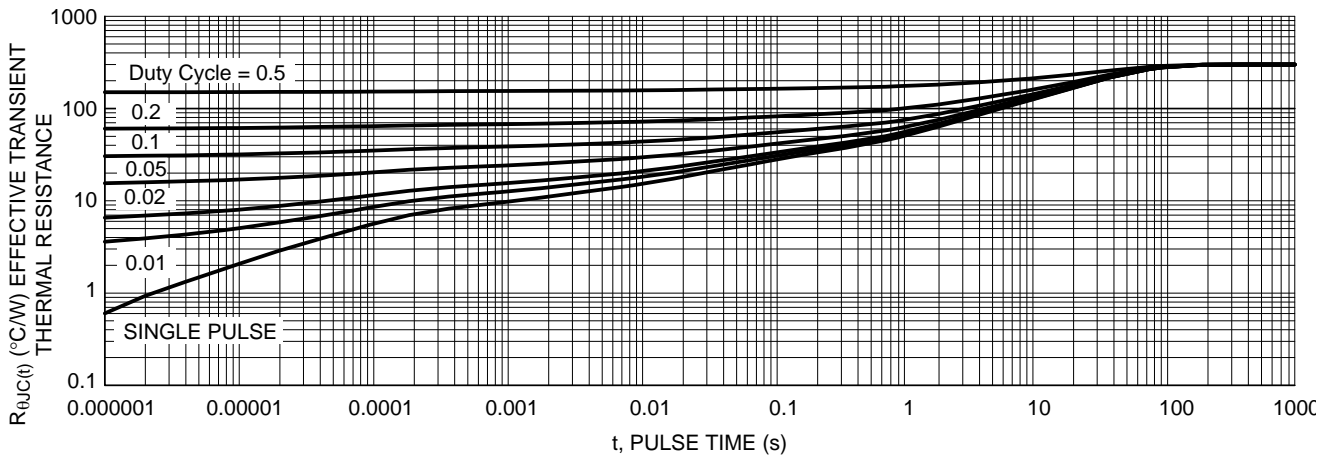

Figure 11. Thermal Response – 1 sq in pad

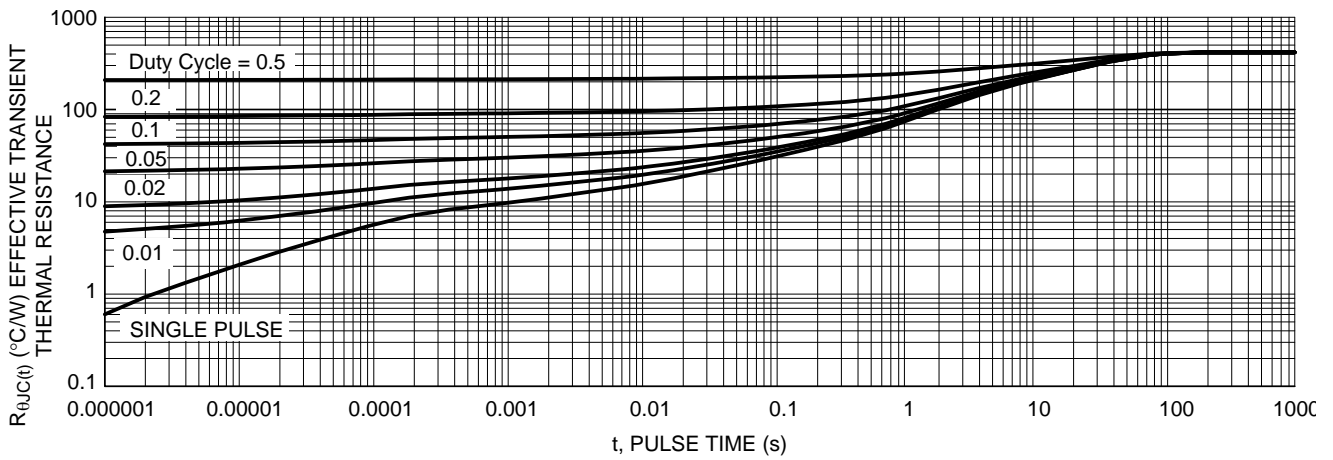
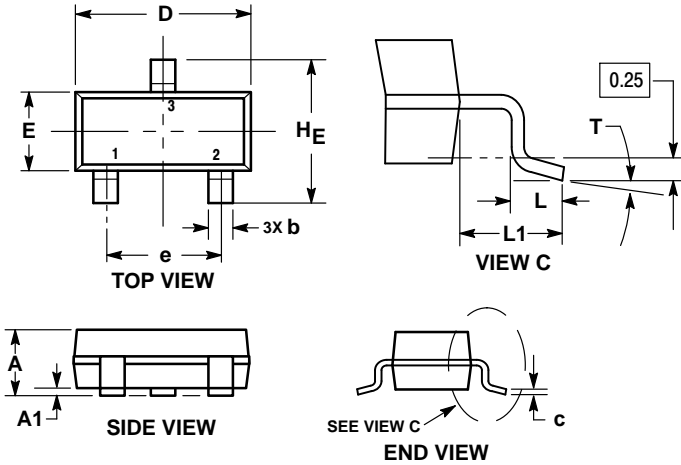

Figure 12. Thermal Response – minimum pad

2N7002K, 2V7002K

PACKAGE DIMENSIONS

SOT-23 (TO-236)
CASE 318-08
ISSUE AR



NOTES:

1. DIMENSIONING AND TOLERANCING PER ASME Y14.5M, 1994.
2. CONTROLLING DIMENSION: MILLIMETERS.
3. MAXIMUM LEAD THICKNESS INCLUDES LEAD FINISH. MINIMUM LEAD THICKNESS IS THE MINIMUM THICKNESS OF THE BASE MATERIAL.
4. DIMENSIONS D AND E DO NOT INCLUDE MOLD FLASH, PROTRUSIONS, OR GATE BURRS.

| DIM | MILLIMETERS | | | INCHES | | |
|-----|-------------|------|------|--------|-------|-------|
| | MIN | NOM | MAX | MIN | NOM | MAX |
| A | 0.89 | 1.00 | 1.11 | 0.035 | 0.039 | 0.044 |
| A1 | 0.01 | 0.06 | 0.10 | 0.000 | 0.002 | 0.004 |
| b | 0.37 | 0.44 | 0.50 | 0.015 | 0.017 | 0.020 |
| c | 0.08 | 0.14 | 0.20 | 0.003 | 0.006 | 0.008 |
| D | 2.80 | 2.90 | 3.04 | 0.110 | 0.114 | 0.120 |
| E | 1.20 | 1.30 | 1.40 | 0.047 | 0.051 | 0.055 |
| e | 1.78 | 1.90 | 2.04 | 0.070 | 0.075 | 0.080 |
| L | 0.30 | 0.43 | 0.55 | 0.012 | 0.017 | 0.022 |
| L1 | 0.35 | 0.54 | 0.69 | 0.014 | 0.021 | 0.027 |
| HE | 2.10 | 2.40 | 2.64 | 0.083 | 0.094 | 0.104 |
| T | 0° | — | 10° | 0° | — | 10° |

STYLE 21:

1. GATE
2. SOURCE
3. DRAIN

RECOMMENDED SOLDERING FOOTPRINT

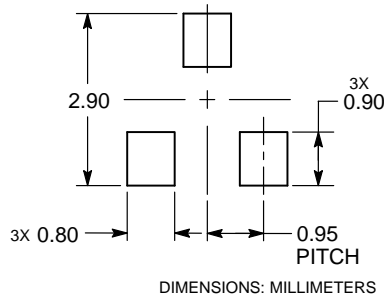

DIMENSIONS: MILLIMETERS

ON Semiconductor and are trademarks of Semiconductor Components Industries, LLC dba ON Semiconductor or its subsidiaries in the United States and/or other countries. ON Semiconductor owns the rights to a number of patents, trademarks, copyrights, trade secrets, and other intellectual property. A listing of ON Semiconductor's product/patent coverage may be accessed at www.onsemi.com/site/pdf/Patent-Marking.pdf. ON Semiconductor reserves the right to make changes without further notice to any products herein. ON Semiconductor makes no warranty, representation or guarantee regarding the suitability of its products for any particular purpose, nor does ON Semiconductor assume any liability arising out of the application or use of any product or circuit, and specifically disclaims any and all liability, including without limitation special, consequential or incidental damages. Buyer is responsible for its products and applications using ON Semiconductor products, including compliance with all laws, regulations and safety requirements or standards, regardless of any support or applications information provided by ON Semiconductor. "Typical" parameters which may be provided in ON Semiconductor data sheets and/or specifications can and do vary in different applications and actual performance may vary over time. All operating parameters, including "Typicals" must be validated for each customer application by customer's technical experts. ON Semiconductor does not convey any license under its patent rights nor the rights of others. ON Semiconductor products are not designed, intended, or authorized for use as a critical component in life support systems or any FDA Class 3 medical devices or medical devices with a same or similar classification in a foreign jurisdiction or any devices intended for implantation in the human body. Should Buyer purchase or use ON Semiconductor products for any such unintended or unauthorized application, Buyer shall indemnify and hold ON Semiconductor and its officers, employees, subsidiaries, affiliates, and distributors harmless against all claims, costs, damages, and expenses, and reasonable attorney fees arising out of, directly or indirectly, any claim of personal injury or death associated with such unintended or unauthorized use, even if such claim alleges that ON Semiconductor was negligent regarding the design or manufacture of the part. ON Semiconductor is an Equal Opportunity/Affirmative Action Employer. This literature is subject to all applicable copyright laws and is not for resale in any manner.

PUBLICATION ORDERING INFORMATION

LITERATURE FULFILLMENT:
Literature Distribution Center for ON Semiconductor
19521 E. 32nd Pkwy, Aurora, Colorado 80011 USA
Phone: 303-675-2175 or 800-344-3860 Toll Free USA/Canada
Fax: 303-675-2176 or 800-344-3867 Toll Free USA/Canada
Email: orderlit@onsemi.com

N. American Technical Support: 800-282-9855 Toll Free USA/Canada
Europe, Middle East and Africa Technical Support:
Phone: 421 33 790 2910
Japan Customer Focus Center
Phone: 81-3-5817-1050

ON Semiconductor Website: www.onsemi.com
Order Literature: <http://www.onsemi.com/orderlit>

For additional information, please contact your local Sales Representative