



# **mikromedia 7**

*for STM32F4*

Amazingly compact, all-on-single-pcb development board carrying 7" TFT Touch Screen and lots of multimedia peripherals, all driven by powerful STM32F407ZG microcontroller from ARM® Cortex™-M4 family



# To our valued customers

I want to express my thanks to you for being interested in our products and for having confidence in MikroElektronika.

The primary aim of our company is to design and produce high quality electronic products and to constantly improve the performance thereof in order to better suit your needs.



Nebojsa Matic  
General Manager

# Table of Contents

Introduction to mikromedia 7 for STM32F4	4	8. Audio Module	22
System Specification	4	9. USB DEVICE connection	24
Package Contains	5	10. USB HOST connection	26
1. Power supply	6	11. Accelerometer	28
2. STM32F407ZG microcontroller	8	12. Flash Memory	30
Key microcontroller features	8	13. RF transceiver	32
3. Programming the microcontroller	9	14. Wi-Fi	34
Using mikroProg™ programmer	10	15. Ethernet transceiver	36
mikroProg™ suite for ARM® software	12	16. CAN communication	38
Software installation wizard	13	17. Buzzer	40
4. RTC Battery and Reset Button	14	18. Other modules	42
5. Crystal oscillators and 2.048V reference	16	19. Pads	44
6. MicroSD Card Slot	18	What's next	46
7. Touch Screen	20		

# Introduction to mikromedia 7 for STM32F4

The **mikromedia 7 for STM32F4** is a compact development system with lots of on-board peripherals which allow development of devices with multimedia contents. The central part of the system is a 32-bit **ARM® Cortex™-M4 STM32F407ZG** 144-pin microcontroller. The mikromedia 7 for STM32F4 features integrated modules such as stereo MP3 codec, **7" TFT 800x480** touch screen display. The increased screen size is ideal for displaying larger amounts of data. The board also contains an accelerometer, microSD card slot, buzzer, IR receiver, RGB LED diode, PIN photodiode, temperature sensor, 2.4GHz RF, WiFi, Ethernet and CAN transceivers, 8 Mbit flash memory, RTC battery, Li-Polimer battery charger, etc. The board also contains MINI-B USB connector, power screw terminals, 2x5 JTAG connector, two 1x26 connection pads, ON/OFF switch and other. It comes with an onboard **mikroProg™** for STM32 programmer and debugger, but can also be programmed with external programmers, such as ST-LINK programmer.

## System Specification



### power supply

Via USB cable [5V DC] or via connector [5-12V DC]



### power consumption

~108 mA with empty MCU via USB cable [when on-board modules are disabled]



### board dimensions

179 x 111 mm  
~[7 x 4.37 inch]



### weight

~250g  
[0.55 lbs]

# Package Contains



1

Damage resistant protective box



2

Development board



3

Roll USB and ethernet cables and headers



4

User's guide



5

Schematic



6

Distancers, plastic pen and microSD card

# 1. Power Supply

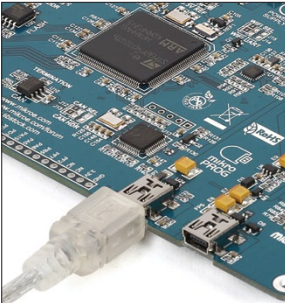

Figure 1-1:  
mikroProg power supply

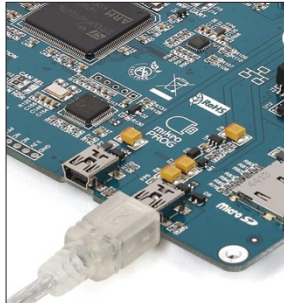

Figure 1-2:  
USB power supply

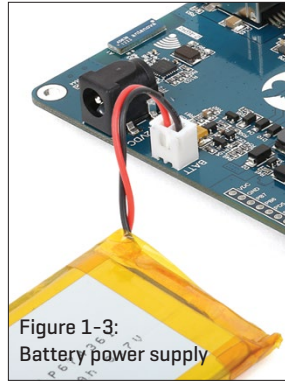

Figure 1-3:  
Battery power supply

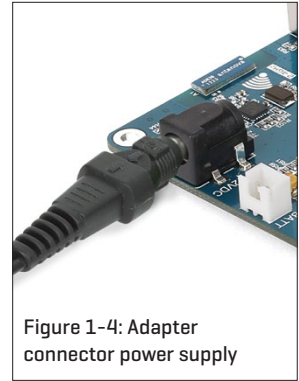

Figure 1-4: Adapter  
connector power supply

The mikromedia 7 for STM32F4 board can be powered in four different ways: via two USB connectors using MINI-B USB cable provided with the board **[CN4 or CN11]**, via battery connector using Li-Polymer battery **[CN5]** or via adapter connector using adapter power supply **[CN3]**. After you plug in the appropriate power supply turn the power switch ON **[SW1]**. The USB connection can provide up to 500mA of current which is more than enough for the operation of all on-board modules and the microcontroller as well. If you decide to use external power supply via screw terminals, voltage values must be within **5-12V DC** range. Power **LED ON [GREEN]** indicates the presence of power supply. On-board battery charger circuit **MCP73832** enables you to charge the battery over USB connection or via screw terminals. **LED diode [RED]** indicates when battery is charging. Charging current is ~250mA and charging voltage is 4.2V DC.

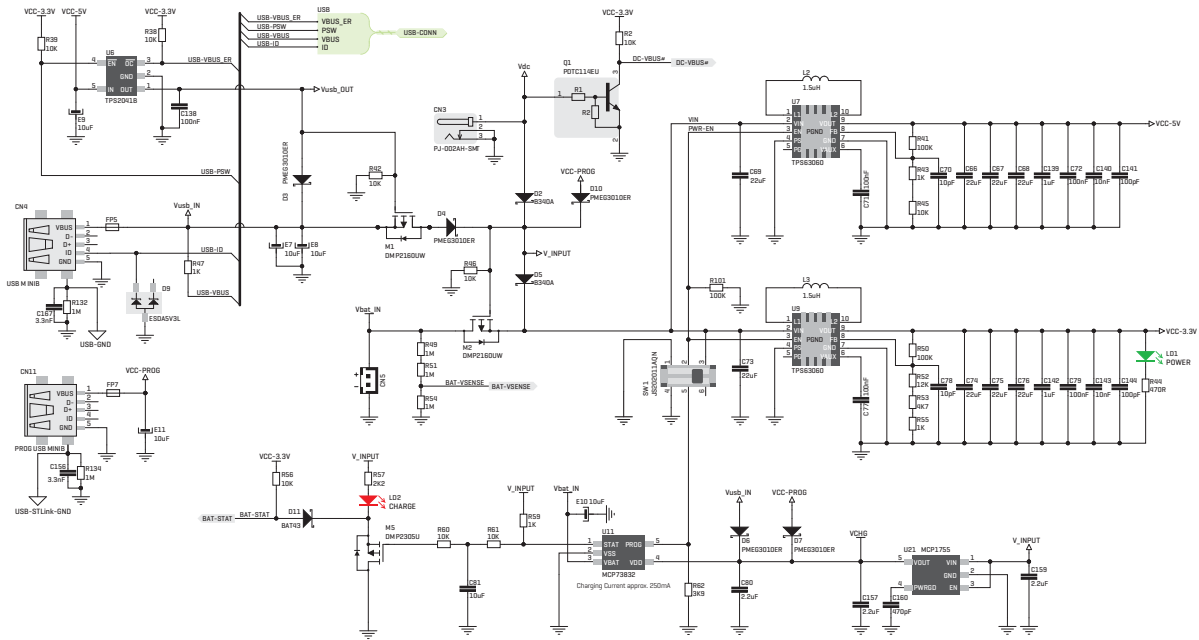

Figure 1-4: Power supply schematic

## 2. STM32F407ZG microcontroller

The mikromedia 7 for STM32F4 development board comes with the 144-pin **ARM® Cortex™-M4 STM32F407ZG** microcontroller. This high-performance **32-bit** microcontroller with its integrated modules and in combination with other onboard modules is ideal for multimedia applications.

### Key microcontroller features

- Up to **210 DMIPS** Operation [168MHz];
- 1 MB of Flash memory;
- 192 + 4 KB of SRAM memory;
- up to 140 I/O pins;
- 16/32-bit timers
- 16MHz internal oscillator, 32kHz RTCC, PLL;
- 4xUART, 3xSPI, 3xI<sup>2</sup>C, 2xCAN, 3xADC, 3XADC etc.
- Ethernet, USB etc.

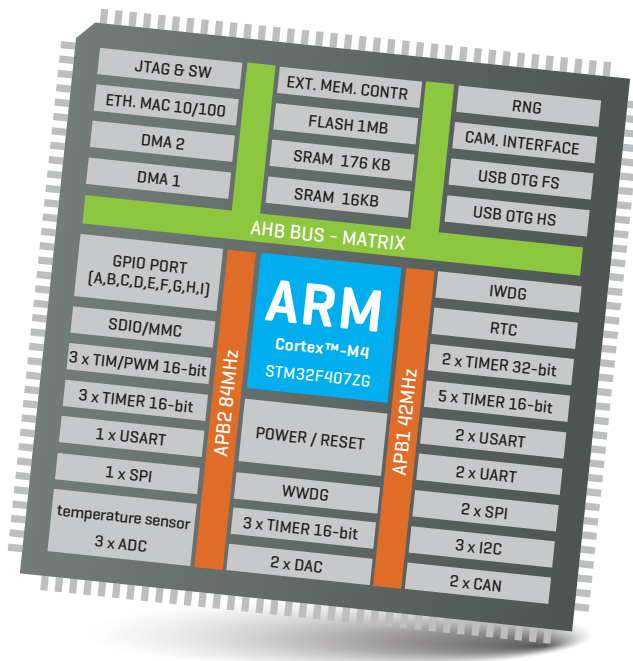



# 3. Programming the microcontroller



Figure 3-1:  
STM32F407ZG  
ARM® Cortex™-M4  
Microcontroller

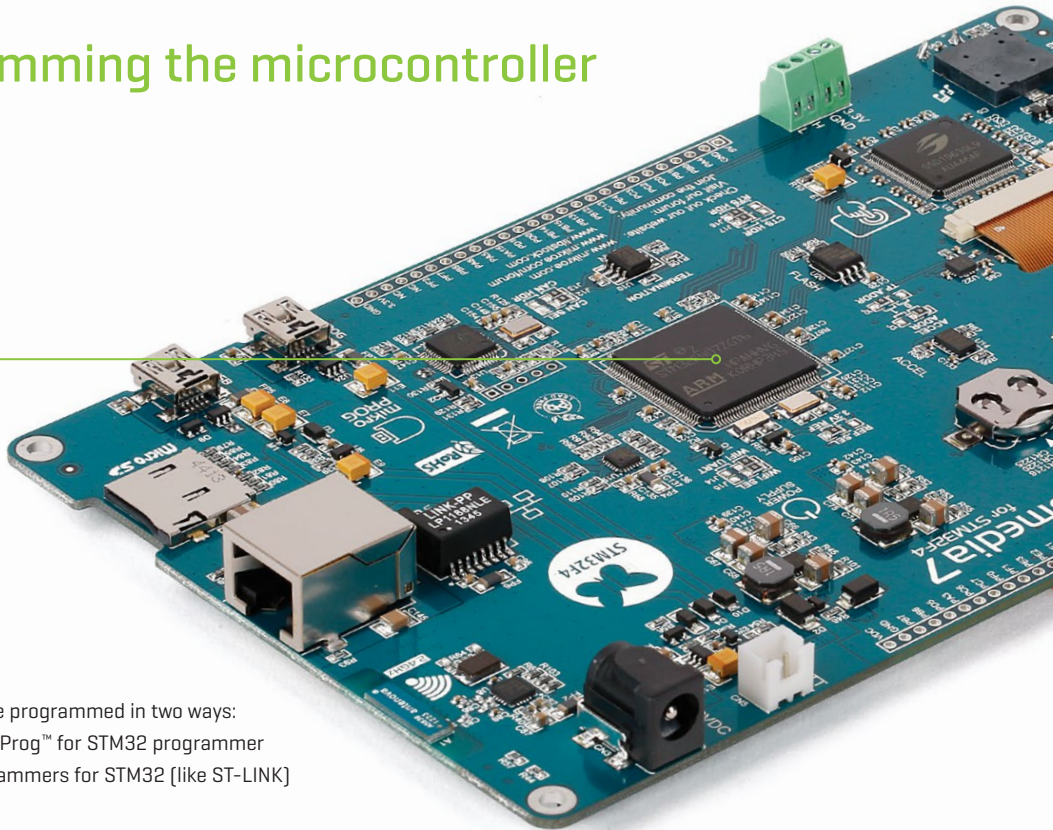

The microcontroller can be programmed in two ways:

1. Using onboard mikroProg™ for STM32 programmer
2. Using external programmers for STM32 [like ST-LINK]

# Using mikroProg™ programmer

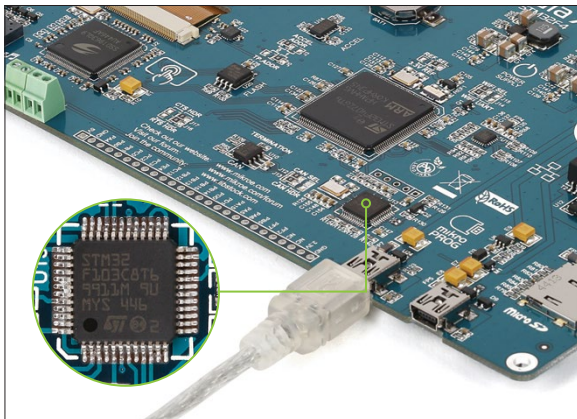

Figure 3-9:  
On-board mikroProg™ programmer

The microcontroller can be programmed with onboard **mikroProg™ for STM programmer** and **mikroProg Suite™ for ARM® software**. Connection with PC is established over an PROG USB connector. For proper insertion of the MINI-B USB cable refer

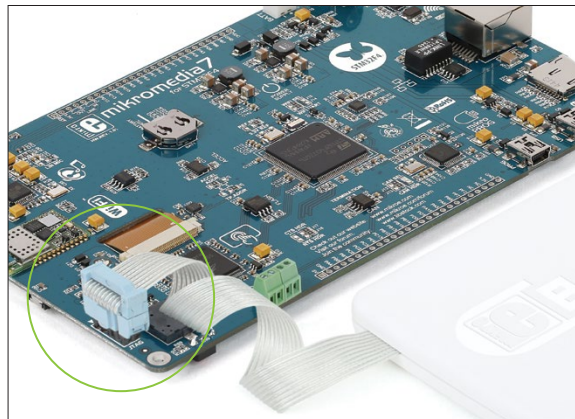

Figure 3-10:  
mikroProg™ JTAG connector

to **Figure 3-9**. Signalization LED [LINK] is also provided on the opposite side of the PROG USB connector. It is also possible to program the microcontroller with external programmers, via 2x5 JTAG connector **[CN1]** with an appropriate adapter, **Figure 3-10**.



# mikroProg Suite™ for ARM® software

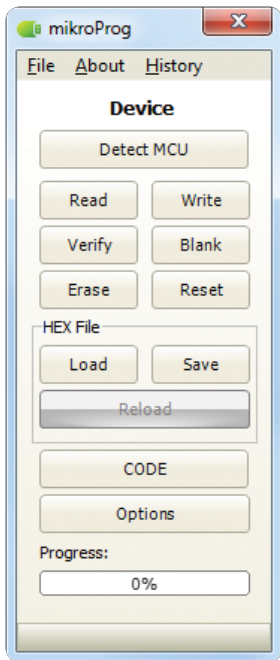

Figure 3-1:  
mikroProg  
Suite™ for  
ARM®  
window

mikroProg™ for STM32 programmer requires special programming software called mikroProg Suite™ for ARM®. This software is used for programming ALL of STM32 ARM® Cortex-M3™ and Cortex-M4™ microcontroller families. It features intuitive interface and SingleClick™ programming technology. Software installation is available on following link:

➔ [www.mikroe.com/downloads/get/1809/mikroprog\\_suite\\_for\\_arm.zip](http://www.mikroe.com/downloads/get/1809/mikroprog_suite_for_arm.zip)

After downloading, extract the package and double click the executable setup file to start installation.

## Quick Guide

1. Click the **Detect MCU** button in order to recognize the device ID.
2. Click the **Read** button to read the entire microcontroller memory. You can click the **Save** button to save it to the target HEX file.
3. If you want to write the HEX file into the microcontroller, first make sure to load the target HEX file using the **Load** button. Then click the **Write** button to begin programming.
4. Click the **Erase** button to clear the microcontroller memory.

# Software installation wizard

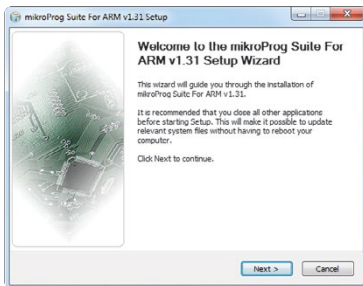

1. Start Installation

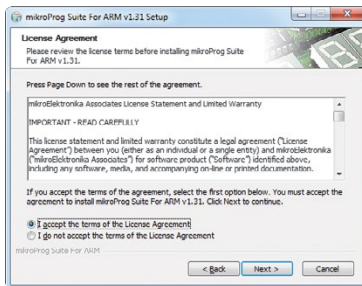

2. Accept EULA and continue

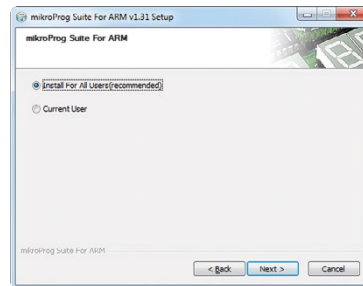

3. Install for all users

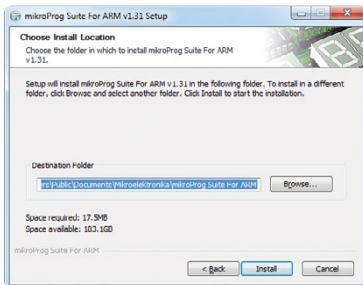

4. Choose destination folder

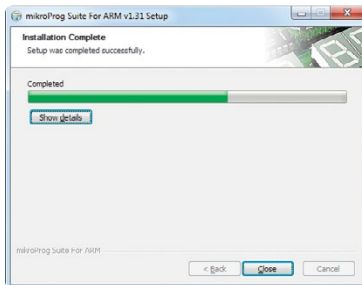

5. Installation in progress



6. Finish installation

## 4. RTC Battery and Reset Button

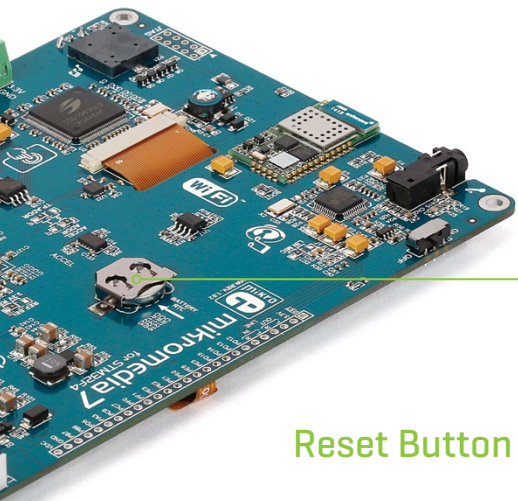

### RTC Battery

mikromedia 7 for STM32F4 features an RTC battery holder for microcontroller RTC module. Battery is used as alternate source of power, so the RTC module can continue to keep time while the primary source of power is off or currently unavailable. Three types of coin battery are supported: CR1216, CR1220 and CR1225.

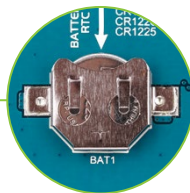

### Reset Button

The board is equipped with reset button, which is located on the front side of the board. If you want to reset the circuit, press the reset button. It will generate low voltage level on the microcontroller reset pin (input). A reset can also be externally provided through the **pin 26** on the side headers.

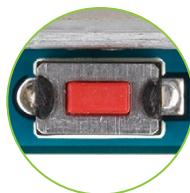

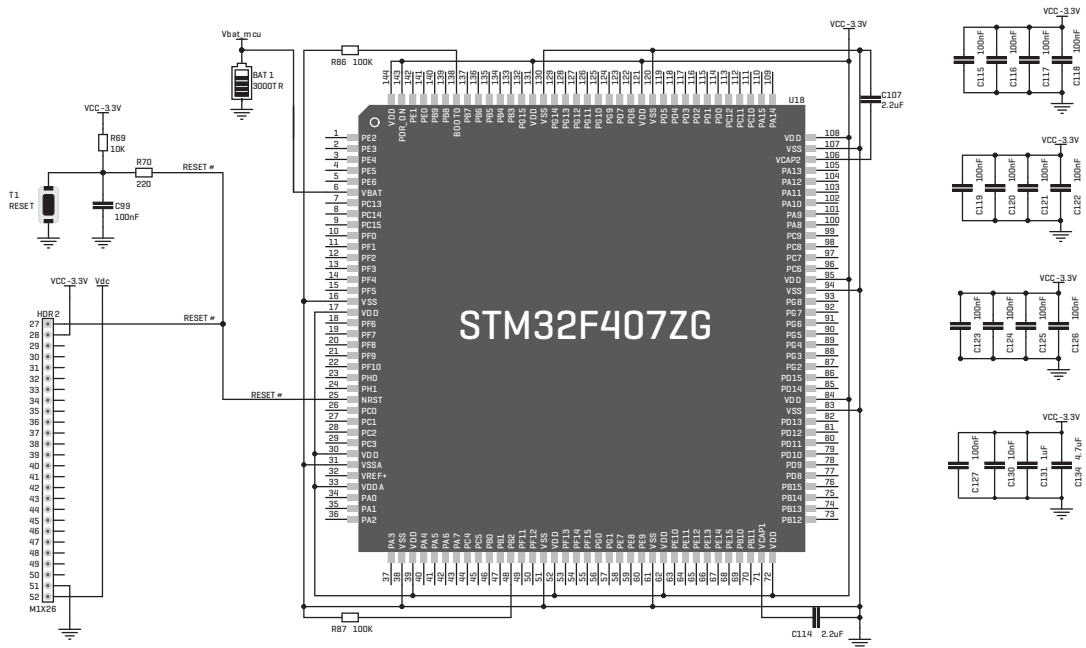

Figure 4-1: Reset circuit and RTC battery schematic

# 5. Crystal oscillators and 2.048V reference

The board is equipped with **1 25MHz crystal oscillator [X5]** circuit that provides external clock waveform to the microcontroller OSC0 and OSC1 pins. This base frequency is suitable for further clock multipliers and ideal for generation of necessary USB clock, which ensures proper operation of bootloader and your custom USB-based applications. The board also contains **2 32.768 kHz crystal oscillator [X4]** which provides external clock for internal RTCC module. Microcontroller ADC requires an accurate source of reference voltage signal. That is why we provide the external **3 voltage reference** to the microcontroller VREF pin which is **2.048V**.

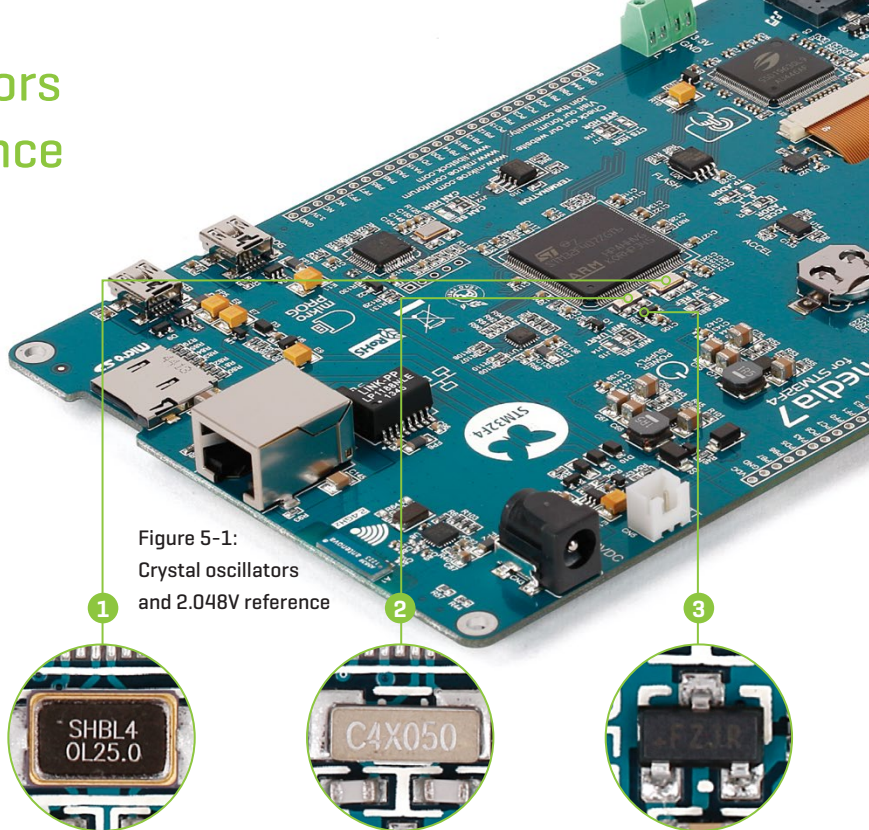

Figure 5-1:  
Crystal oscillators  
and 2.048V reference



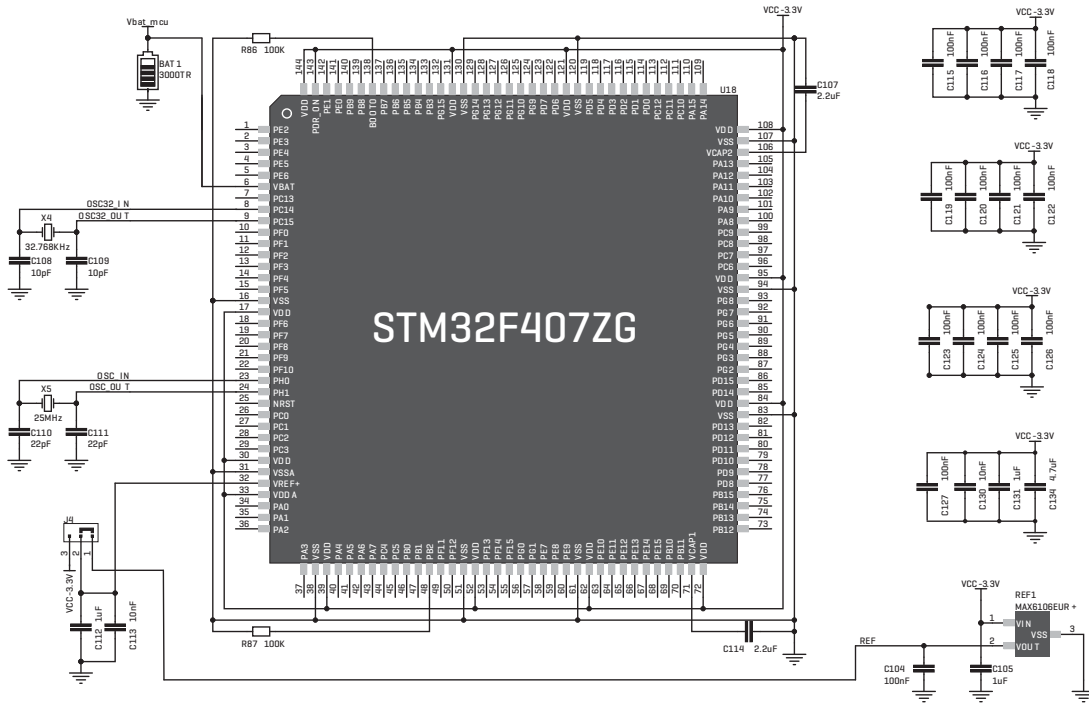
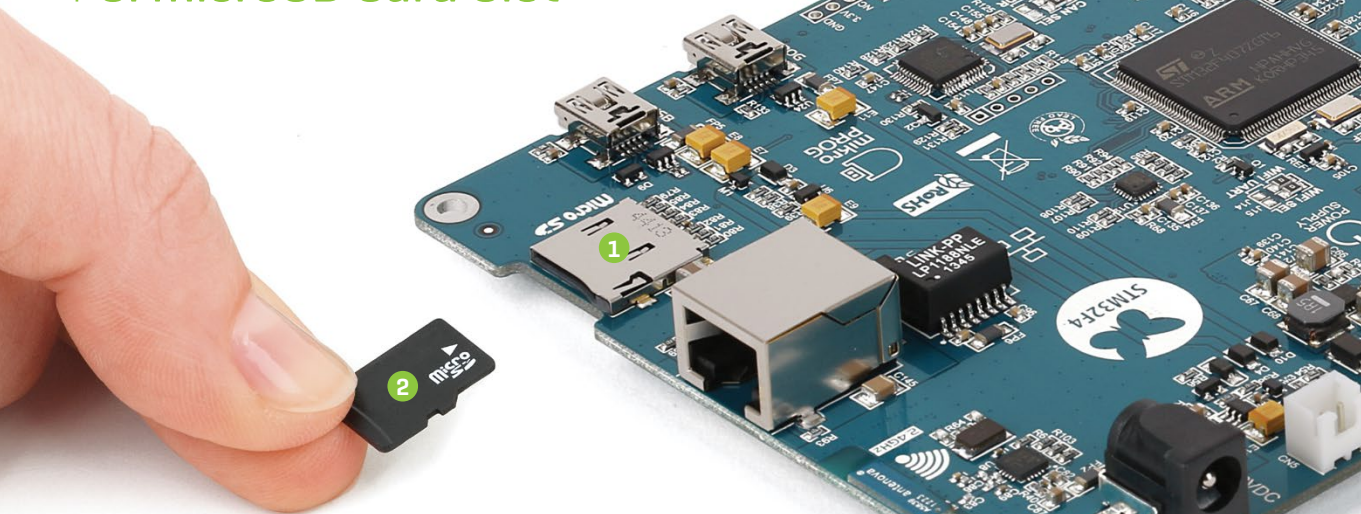

Figure 5-2: Crystal oscillator and voltage reference schematic

## 6. microSD Card Slot



Board contains **1** microSD card slot for using **2** microSD cards in your projects. It enables you to store large amounts of data externally, thus saving microcontroller memory. microSD cards use Serial Peripheral Interface [**SPI**] for communication with the microcontroller. Ferrite and capacitor are provided to compensate the voltage and current glitch that can occur when pushing-in and pushing-out microSD card into the socket. Proper insertion of the microSD card is shown in **Figure 6-1**.

**Figure 6-1:**  
microSD card slot



## 7. Touch Screen



The development system features a **7" TFT 800x480 display** covered with a **resistive touch panel**. Together they form a functional unit called a **touch screen**, [Figure 7-1]. It enables data to be entered and displayed at the same time. The TFT display is capable of showing graphics in **262K different colors**.

Figure 7-1: Touch Screen

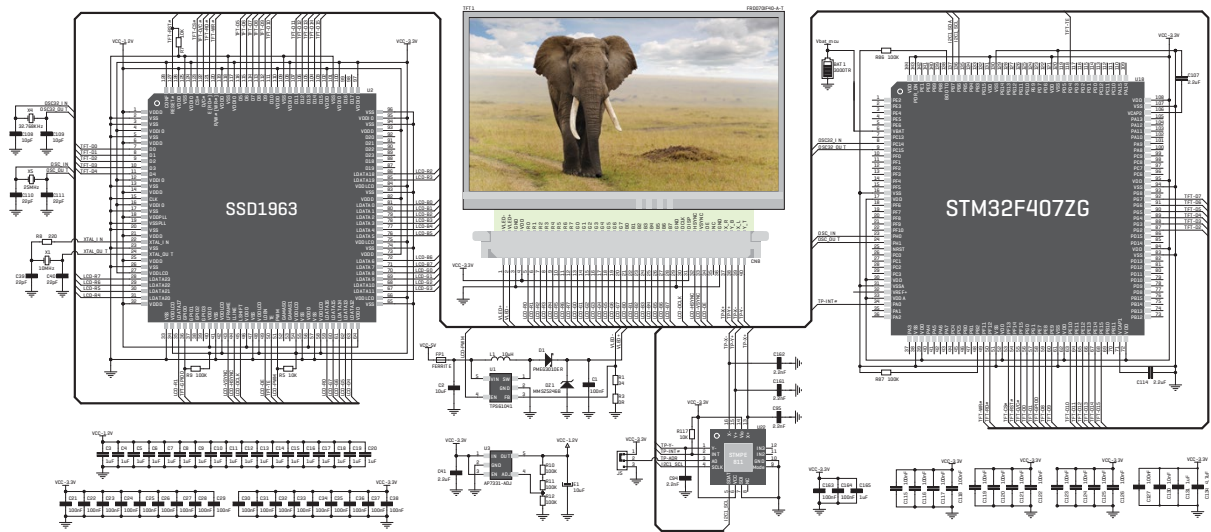
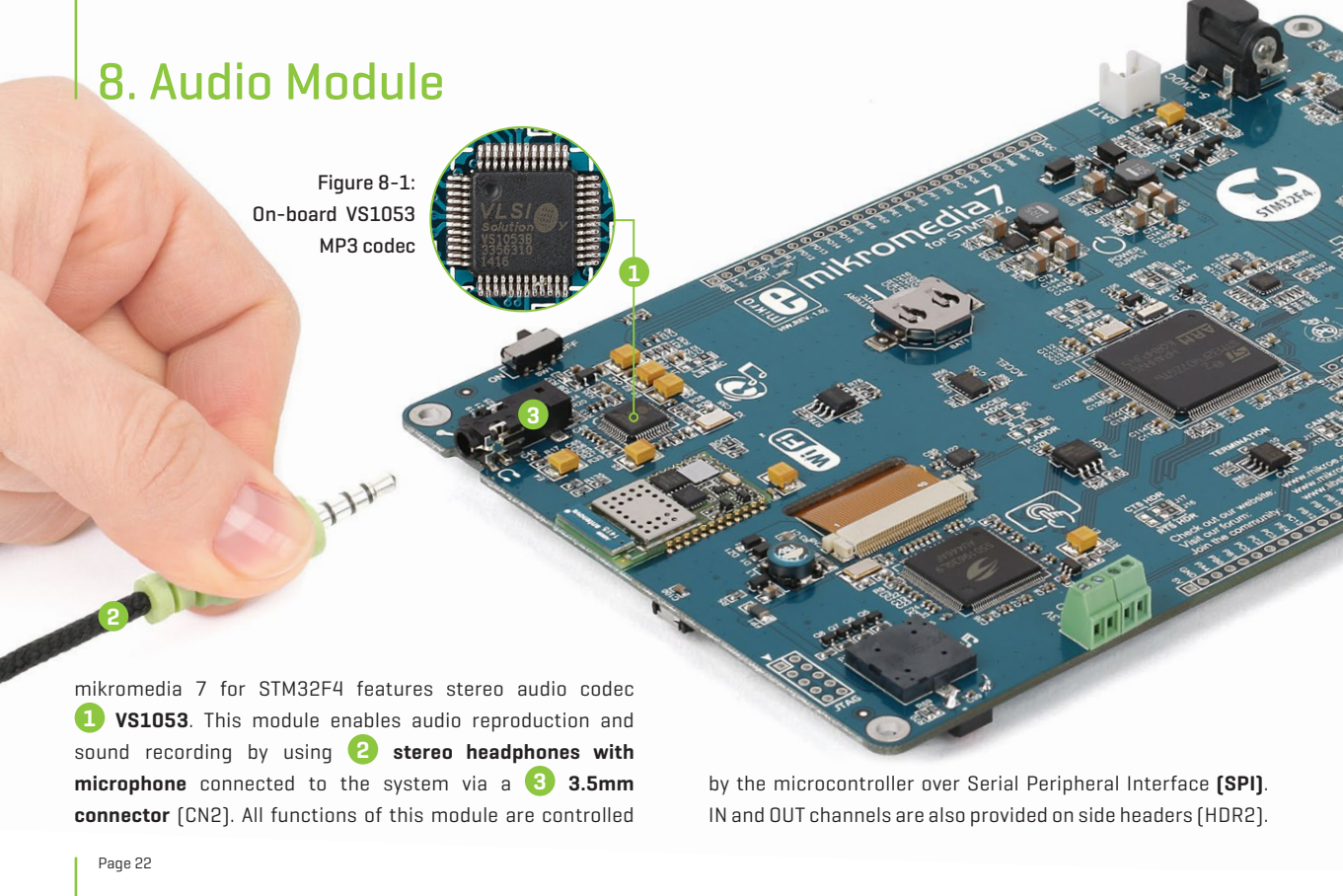

Figure 7-2: Touch Screen connection schematic

# 8. Audio Module

Figure 8-1:  
On-board VS1053  
MP3 codec



mikromedia 7 for STM32F4 features stereo audio codec **1 VS1053**. This module enables audio reproduction and sound recording by using **2 stereo headphones with microphone** connected to the system via a **3 3.5mm connector** [CN2]. All functions of this module are controlled

by the microcontroller over Serial Peripheral Interface [SPI]. IN and OUT channels are also provided on side headers [HDR2].

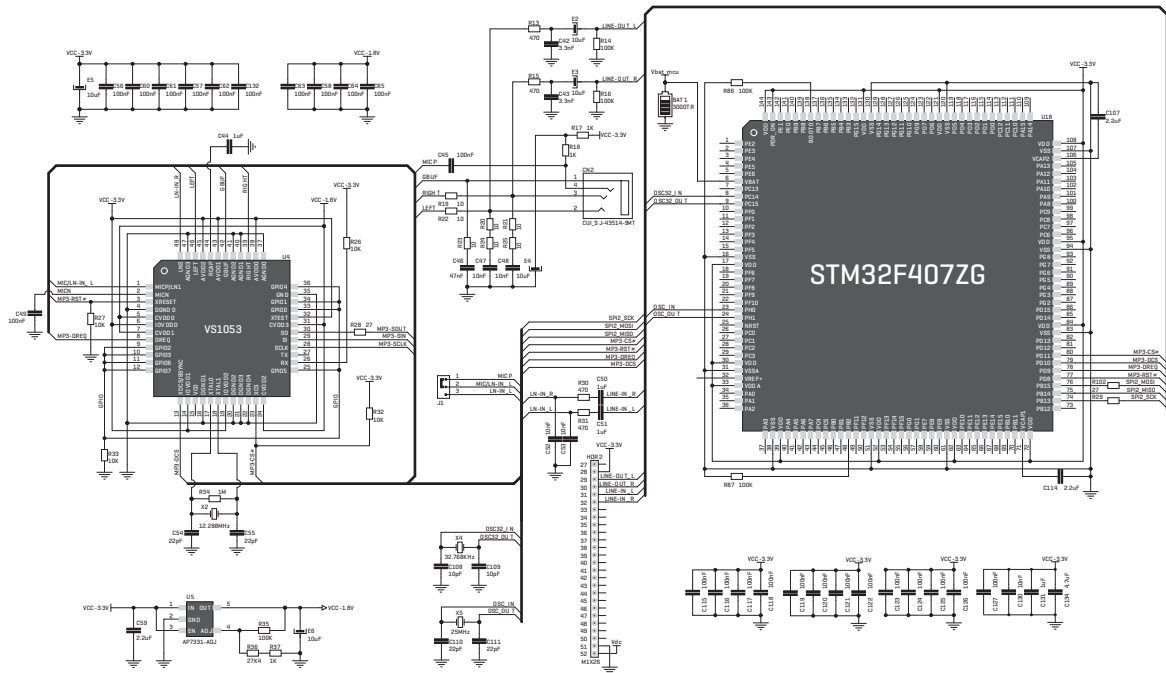

Figure 8-2: Audio module connection schematic

## 9. USB DEVICE connection

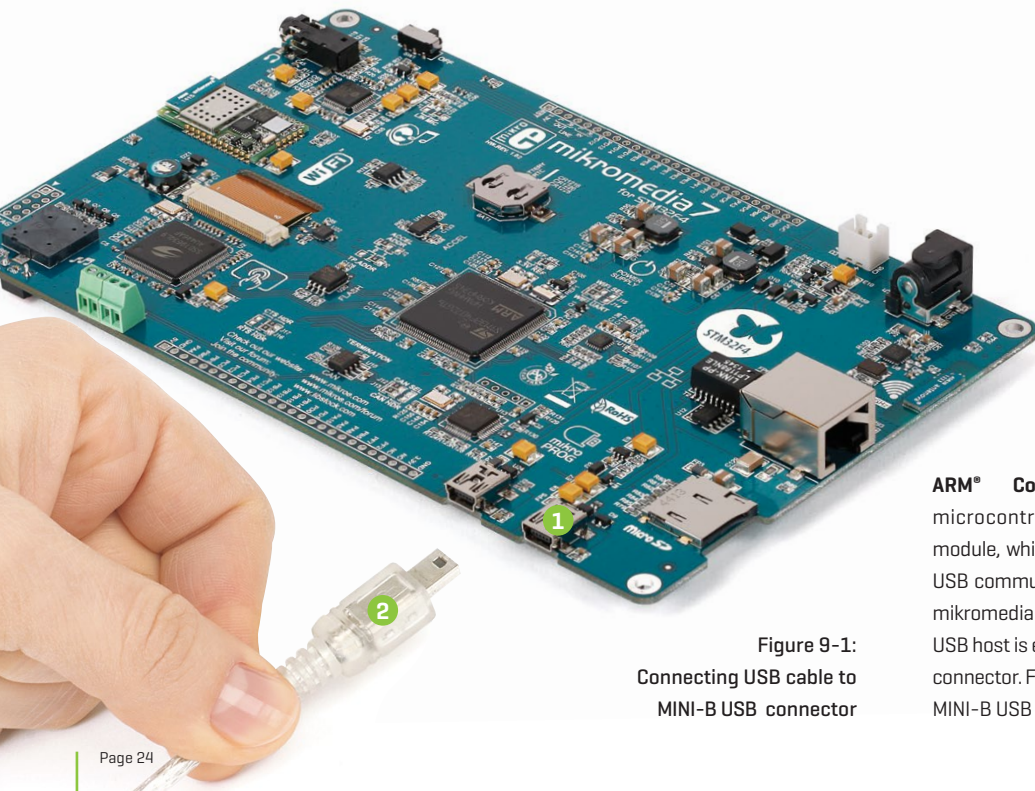

Figure 9-1:  
Connecting USB cable to  
MINI-B USB connector

**ARM® Cortex™-M4 STM32F407ZG** microcontroller has integrated USB module, which enables you to implement USB communication functionality to your mikromedia board. Connection with target USB host is establish over **1** MINI-B USB connector. For proper insertion of the **2** MINI-B USB cable refer to **Figure 9-1**.



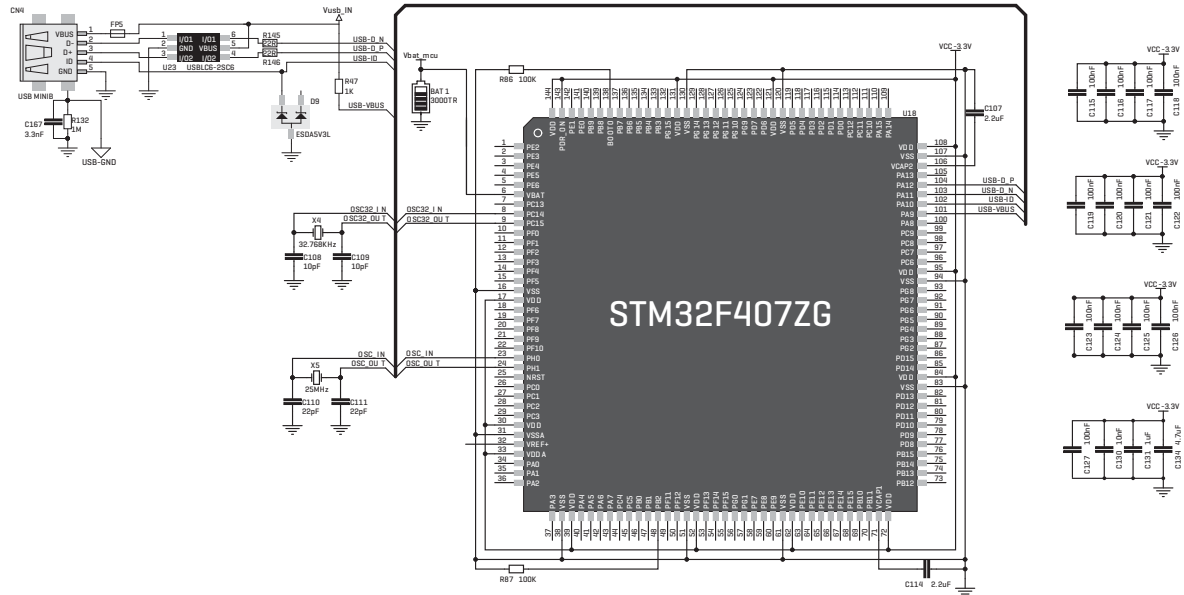
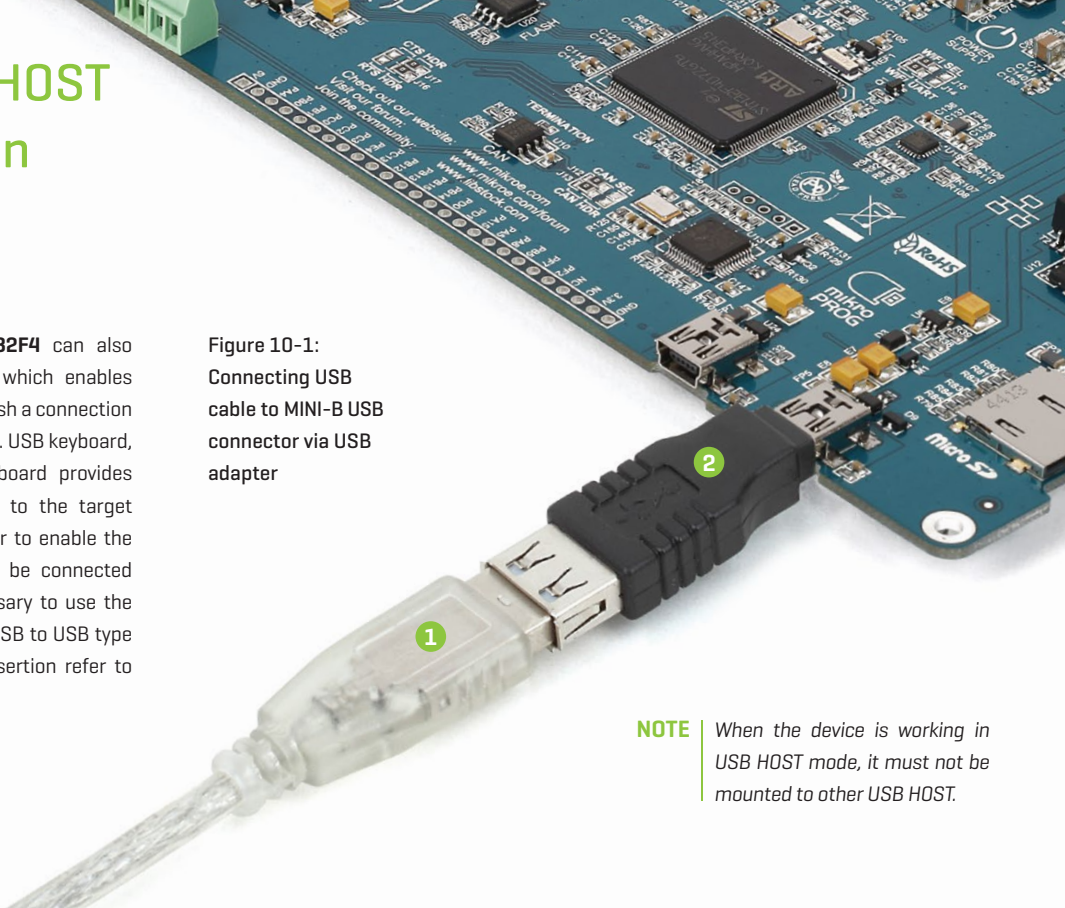

Figure 9-2: USB DEVICE module connection schematic

# 10. USB HOST connection

**mikromedia 7 for STM32F4** can also be used as USB HOST which enables microcontroller to establish a connection with the target device [eg. USB keyboard, USB mouse, etc]. The board provides necessary power supply to the target via TPS2041B IC. In order to enable the **1** USB HOST cable to be connected to the board, it is necessary to use the appropriate **2** MINI-B USB to USB type A adapter. For proper insertion refer to **Figure 10-1**.

Figure 10-1:  
Connecting USB  
cable to MINI-B USB  
connector via USB  
adapter



**NOTE** When the device is working in USB HOST mode, it must not be mounted to other USB HOST.







# 12. Flash Memory



Figure 12-1:  
Flash memory  
module

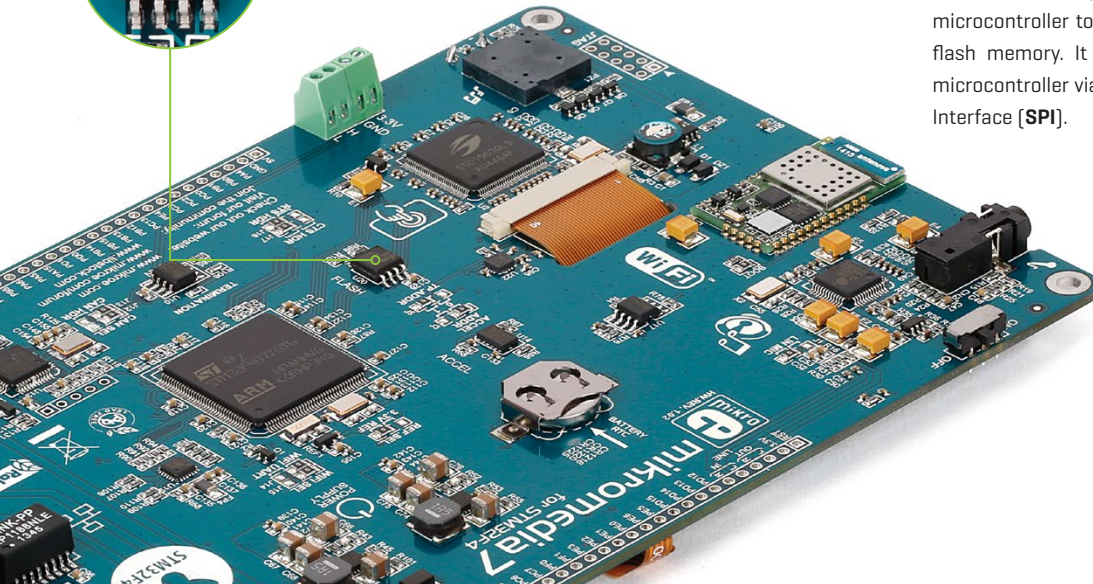

Since multimedia applications are getting increasingly demanding, it is necessary to provide additional memory space to be used for storing more data. The flash memory module enables the microcontroller to use additional **8Mbit** flash memory. It is connected to the microcontroller via the Serial Peripheral Interface [**SPI**].

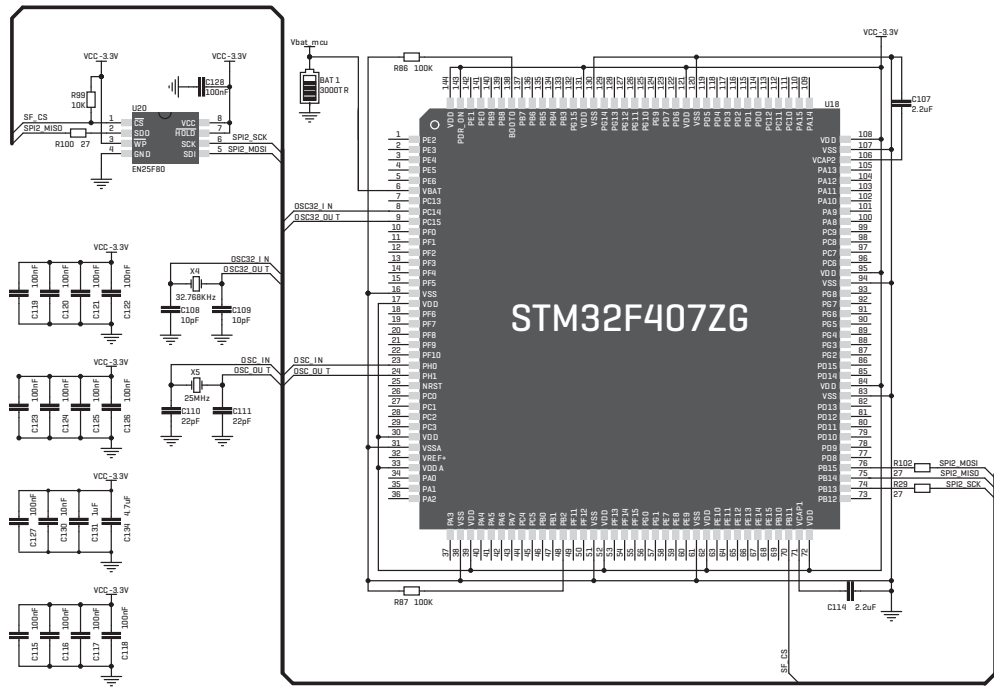

Figure 12-2: Flash memory module connection schematic

# 13. RF Transceiver

mikromedia 7 for STM32F4 board features **RF transceiver** chip with **2.4GHz chip antenna**. It is suitable for wireless operation in the world wide ISM frequency band at 2.400 - 2.4835 GHz with air data rate up to 2Mbps. RF transceiver module is connected to the microcontroller

via the Serial Peripheral Interface (**SPI**). This RF transceiver module is widely used for wireless PC peripherals, remote controllers, VoIP headsets, game controllers, sensors, home and commercial automation, active RFID, toys and many more.

Figure 13-1:  
RF transceiver antenna

Figure 13-2:  
RF transceiver module

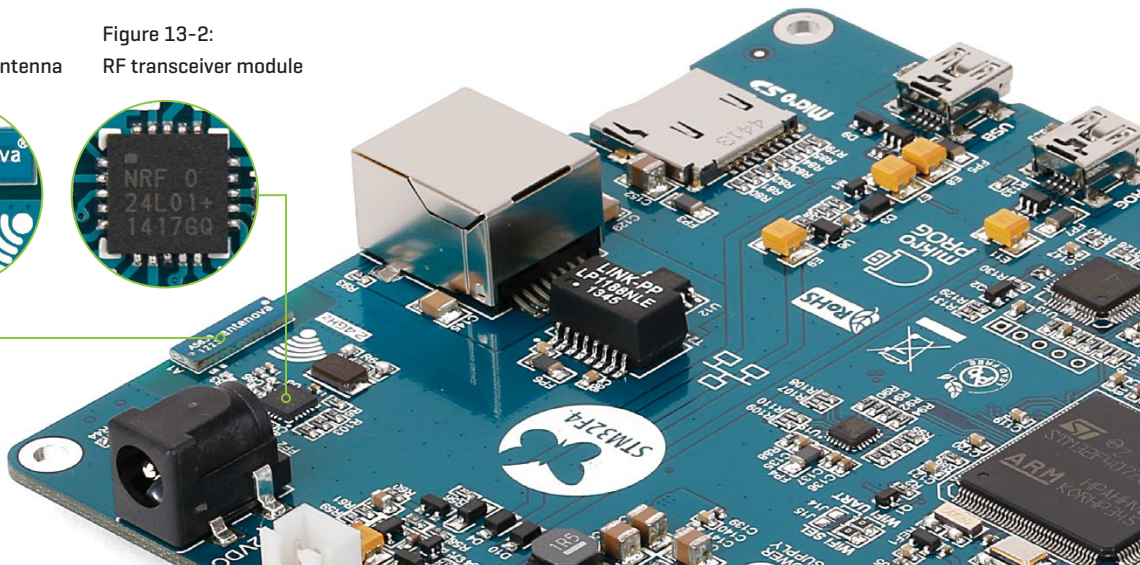





## 14. Wi-Fi

mikromedia 7 for STM32F4 is equipped with SPWF01SA, a WiFi module with an integrated antenna from STMicroelectronics. The module packs a 2.4 GHz IEEE 802.11 b/g/n transceiver and its own STM32 ARM Cortex-M3 MCU that offloads the workload from

the main microcontroller on the mikromedia. Full featured TCP/IP protocol stacks are also integrated. A BOOT jumper (zero ohm resistor) for updating the firmware on the WiFi module is located nearby, between the module itself and the WiFi silkscreen markings.

Figure 14-1: 2.4GHz ceramic chip antenna

Figure 14-2: Wi-Fi 802.11b/g network processor

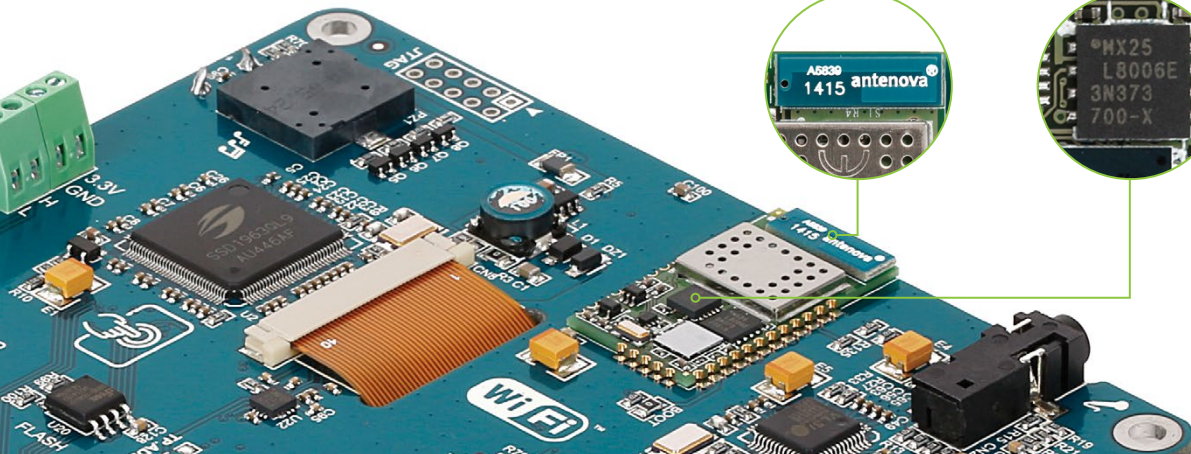

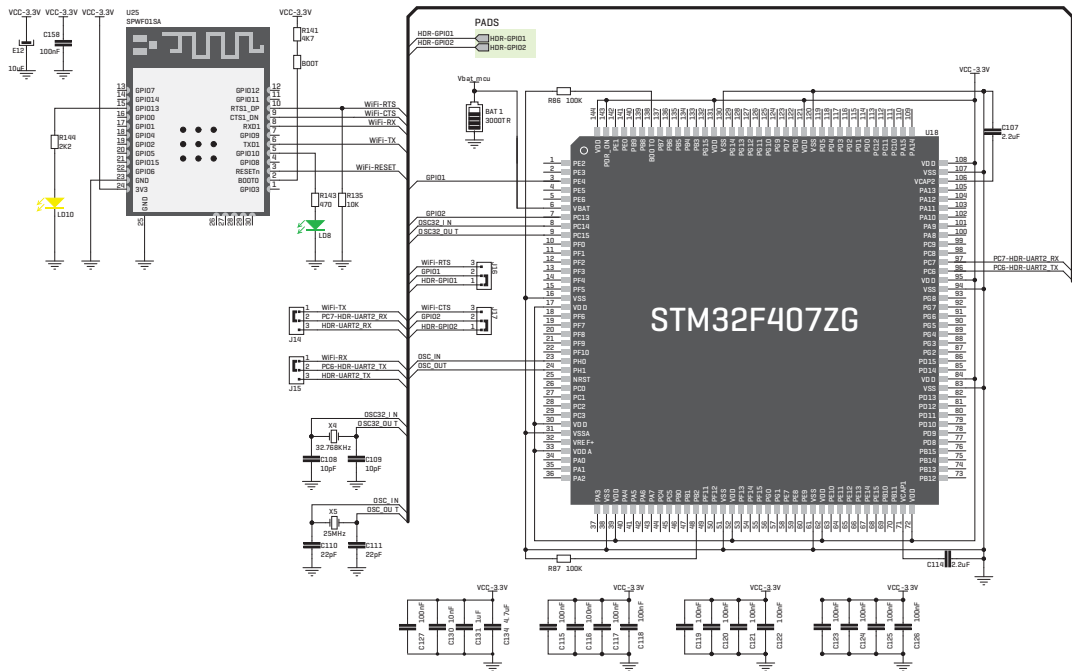

Figure 14-3: Wi-Fi connection schematic

# 15. Ethernet transceiver



Figure 15-1: Ethernet transceiver module [LAN8720A]

Figure 15-2: Ethernet RJ-45 connector

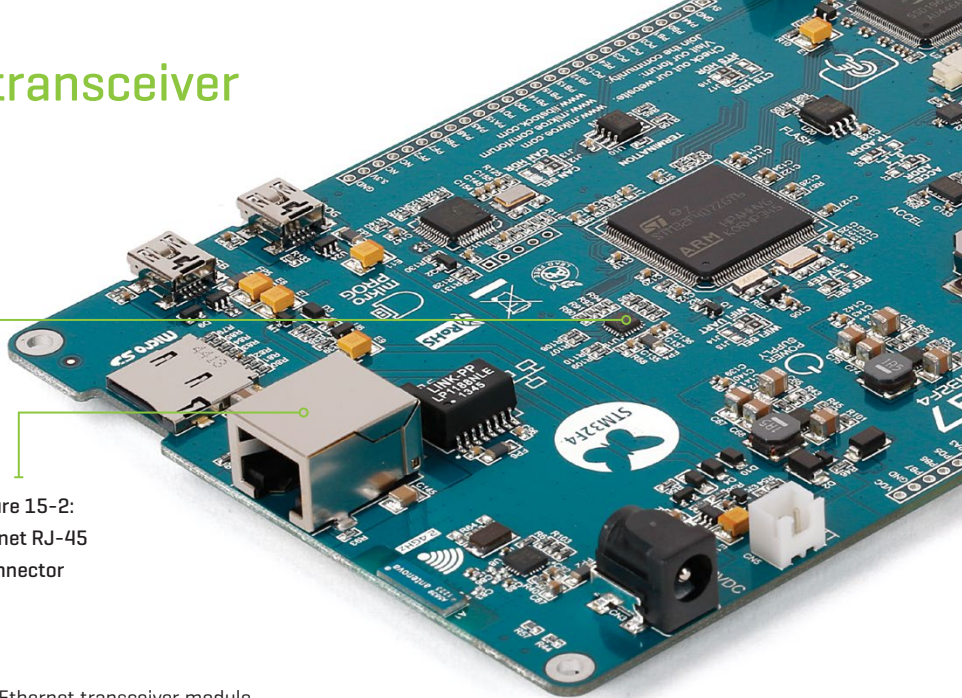

The development board features an Ethernet transceiver module LAN8720A. It is ideal for local area networking [LAN]. If you want to establish connection with a computer, router or other devices, the development board also contains a standard **RJ-45** connector. Communication over Ethernet is based on data packets called

frames. Each frame contains source and destination addresses and error-checking data so that damaged data can be detected and retransmitted. Signalization LEDs (green and yellow) are on the opposite side of the board.



# 16. CAN communication

Controller Area Network (CAN or CAN bus) is a vehicle bus standard designed to allow microcontrollers and devices to communicate with each other within a vehicle without a host computer. CAN is a message-based protocol, designed specifically for automotive applications but now also used in other areas such as industrial automation and medical equipment. mikromedia 7 for STM32F4 is equipped with **SN65HVD230** – a 3.3V CAN transceiver and a pair of screw terminals which provide microcontrollers with integrated CAN controller with the necessary physical interface for CAN communication. Make sure to correctly connect negative and positive differential communication lines before using this module.

Figure 16-1: CAN connector

## Node termination jumper

If the board is the first and the last node of the CAN network, then **TERMINATION** jumper should be placed. If the board is a node in the middle, the jumper should be removed.

Figure 16-2: CAN transceiver with Node TERMINATION jumper

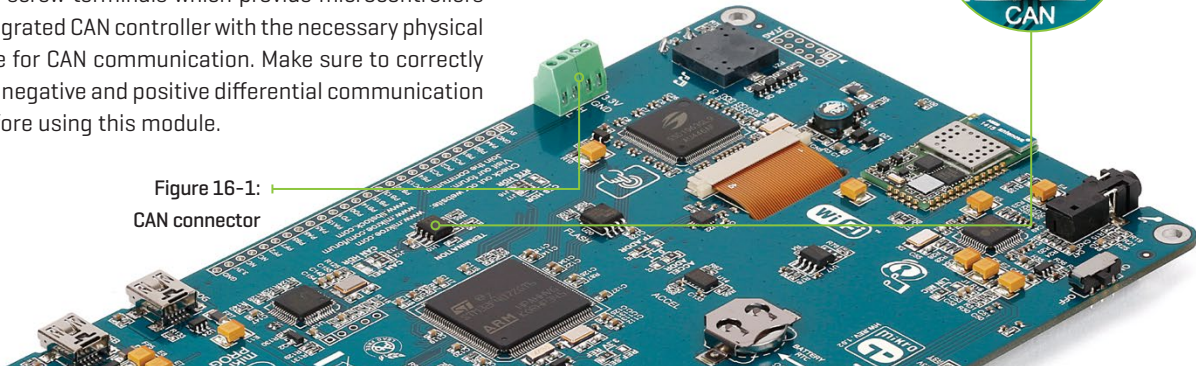

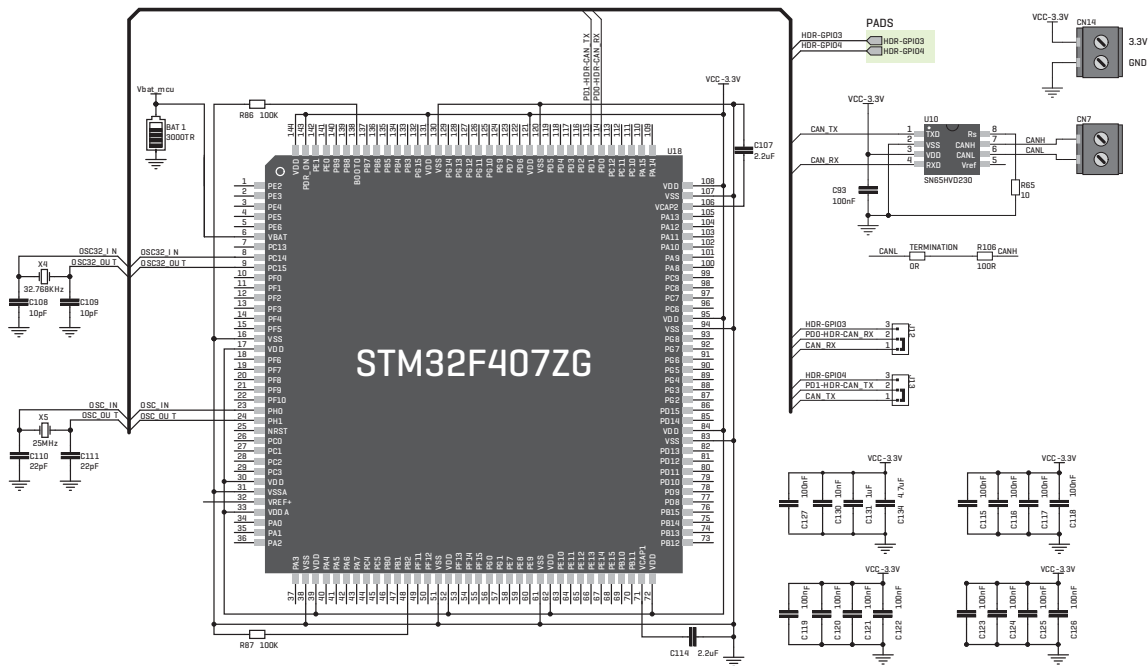

Figure 16-3: CAN connection schematic

## 17. Buzzer

The board is also equipped with a piezo buzzer. It is an electric component which can be used to create sound waves when provided with electrical signal. Microcontroller can create sound

by generating a PWM signal. Frequency of the signal determines the pitch of the sound and duty cycle of the signal can be used to increase or decrease the volume.

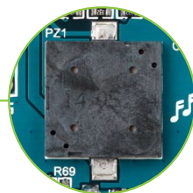
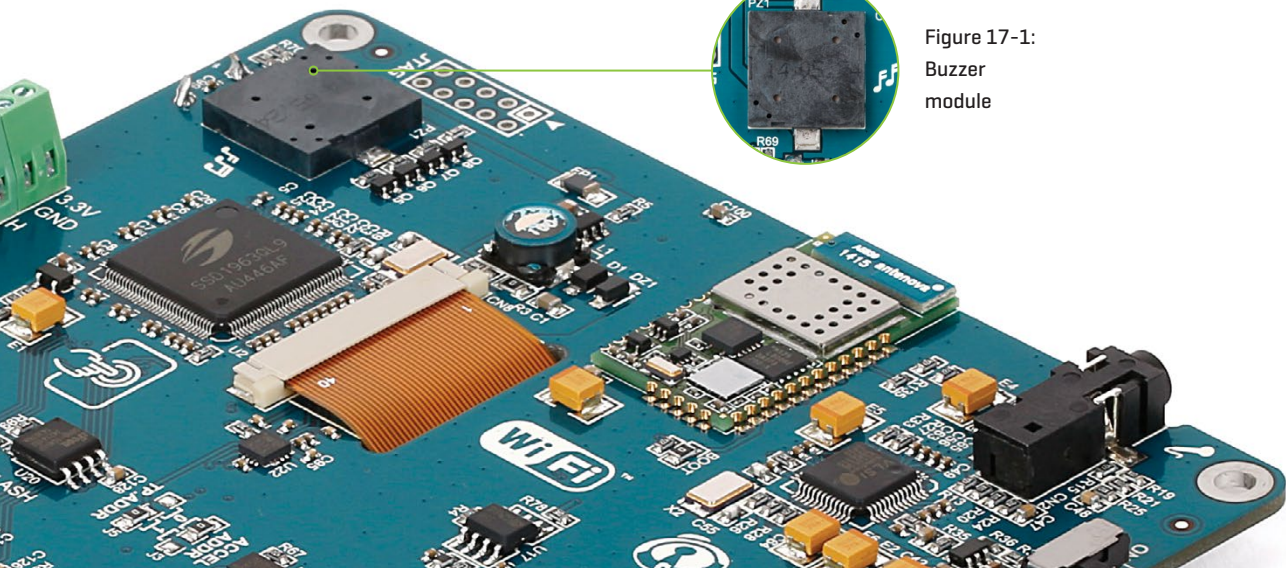

Figure 17-1:  
Buzzer  
module





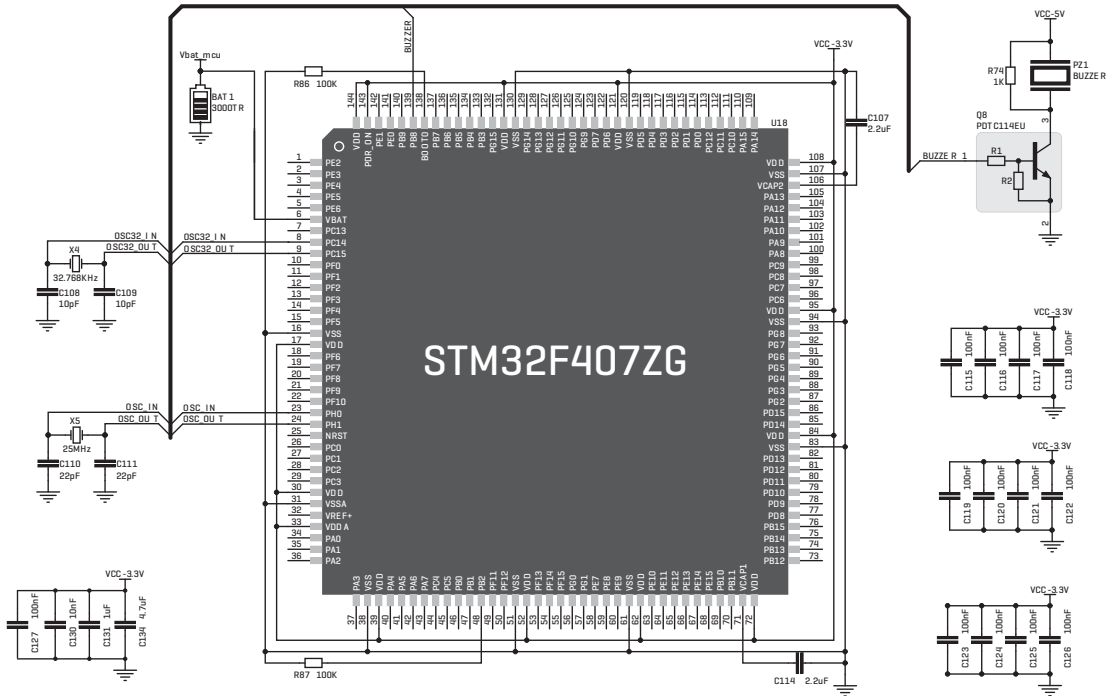
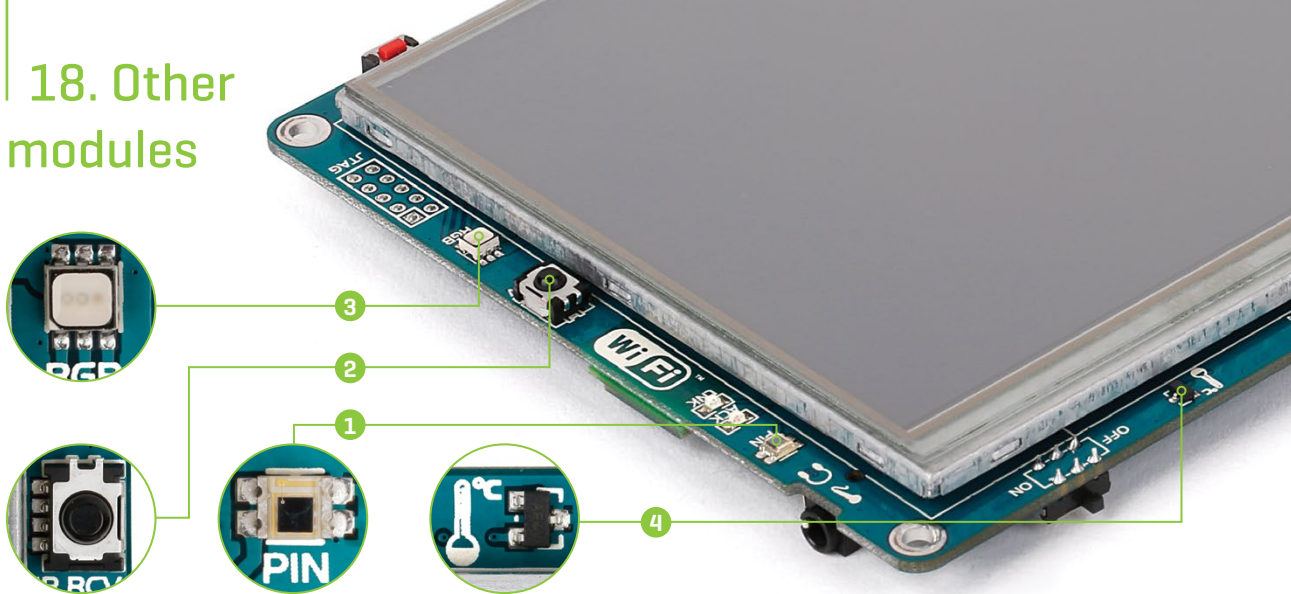

Figure 17-2: Buzzer module schematic

## 18. Other modules



The board also contains additional peripherals that can be very useful, such as **1** PIN photodiode, **2** IR receiver, **3** RGB led diode and **4** analog temperature sensor. **PIN photodiode** is a type of photo detector capable of converting light into the voltage with high sensitivity and speed of response. It is connected to the microcontroller analog pin. **IR receiver** is used for infrared remote control systems. The demodulated output signal obtained from IR

module can be directly decoded by a microcontroller. Many of existing standard data formats are supported. **RGB [Red, Green, Blue] diode** is suitable for light indication in your design. Each of colour is driven separately by transistor. The **analog temperature sensor** converts temperature to analog voltage and it is directly connected to the microcontroller analog pin. Temperature measurement range of mikromedia 7 for STM32F4 board is from  $-20^{\circ}\text{C}$  to  $70^{\circ}\text{C}$ .



# 19. Pads

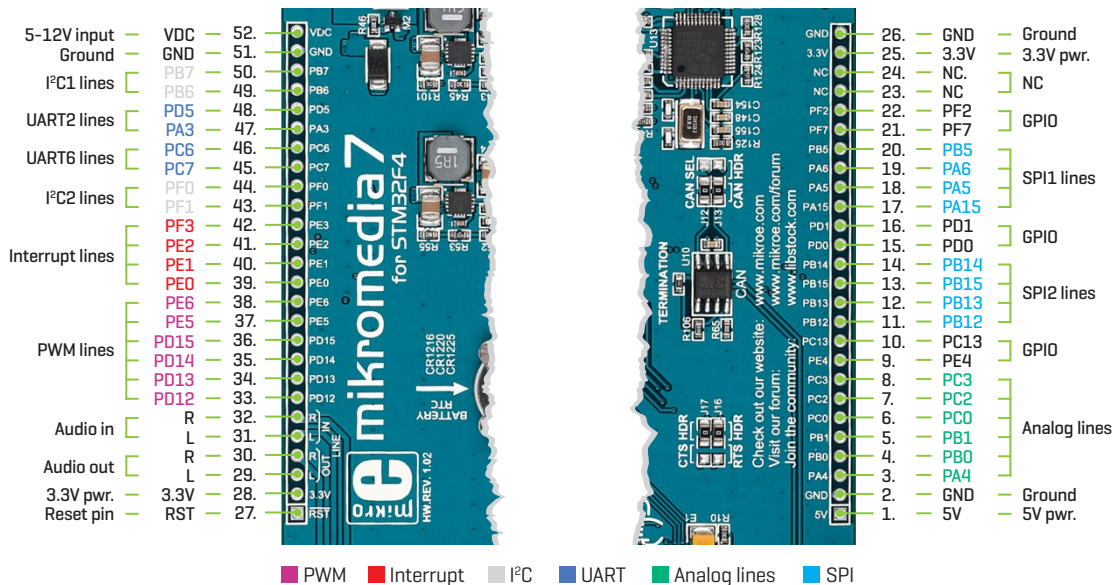

Many microcontroller pins are available for further connectivity via two 1x26 rows of connection pads on both sides of the board. They are designed to match with mikromedia 7 SHIELD for STM32F4.

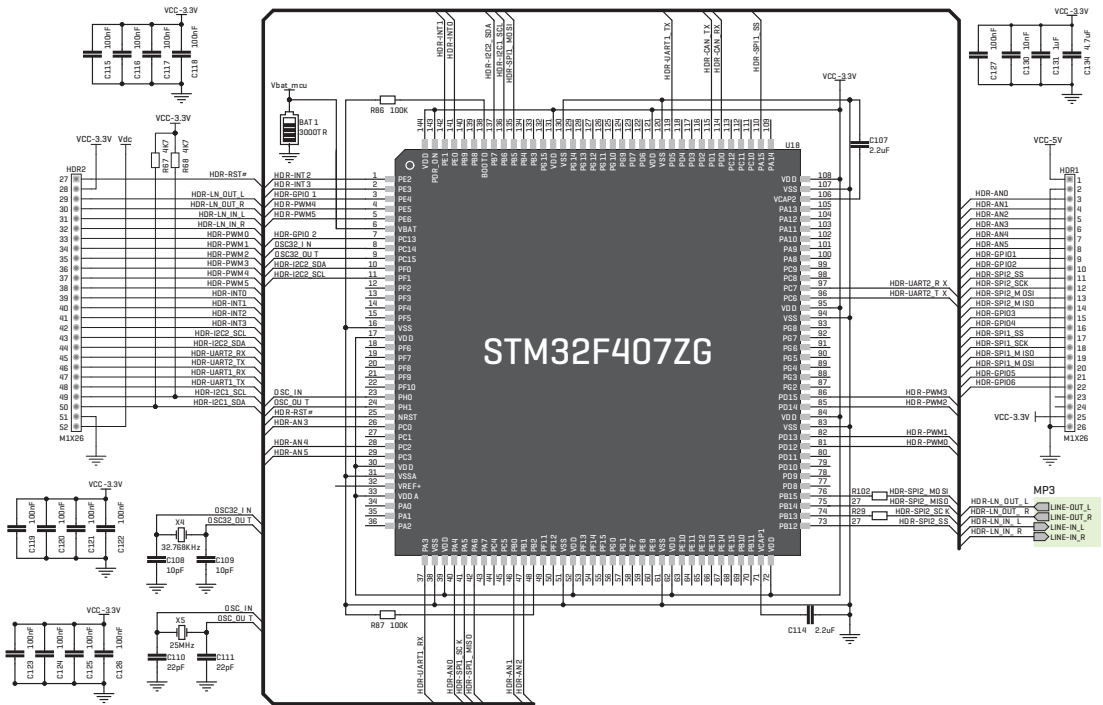

Figure 19-1: Connecting pads schematic

## What's next?

You have now completed the journey through each and every feature of mikromedia 7 for STM32F4 board.

You got to know its modules and organization. Now you are ready to start using your new board. We are suggesting several steps which are probably the best way to begin.

Find useful projects and tutorials on the **Libstock website** ([www.libstock.com](http://www.libstock.com)).

Join our **Forum** ([www.mikroe.com/forum](http://www.mikroe.com/forum)) and get help from a large ecosystem of users.

## Compiler

You still don't have an appropriate compiler? Locate ARM® compiler that suits you best on our website:

[www.mikroe.com/arm/compilers](http://www.mikroe.com/arm/compilers)

Choose between mikroC™, mikroBasic™ and mikroPascal™ and download a fully functional demo version, so you can start building your first applications.



## Visual TFT

Once you have chosen your compiler, and since you already got the board, you are ready to start writing your first projects. **Visual TFT software** enables you to quickly create your GUI. It will automatically generate code compatible with MikroElektronika compilers. Visual TFT is rich with examples, which are an excellent starting point for your future projects. Download it from the link below:

[www.mikroe.com/visualtft](http://www.mikroe.com/visualtft)



# DISCLAIMER

All the products owned by MikroElektronika are protected by copyright law and international copyright treaty. Therefore, this manual is to be treated as any other copyright material. No part of this manual, including product and software described herein, may be reproduced, stored in a retrieval system, translated or transmitted in any form or by any means, without the prior written permission of MikroElektronika. The manual PDF edition can be printed for private or local use, but not for distribution. Any modification of this manual is prohibited. MikroElektronika provides this manual 'as is' without warranty of any kind, either expressed or implied, including, but not limited to, the implied warranties or conditions of merchantability or fitness for a particular purpose. MikroElektronika shall assume no responsibility or liability for any errors, omissions and inaccuracies that may appear in this manual. In no event shall MikroElektronika, its directors, officers, employees or distributors be liable for any indirect, specific, incidental or consequential damages (including damages for loss of business profits and business information, business interruption or any other pecuniary loss) arising out of the use of this manual or product, even if MikroElektronika has been advised of the possibility of such damages. MikroElektronika reserves the right to change information contained in this manual at any time without prior notice, if necessary.

## HIGH RISK ACTIVITIES

The products of MikroElektronika are not fault – tolerant nor designed, manufactured or intended for use or resale as on – line control equipment in hazardous environments requiring fail – safe performance, such as in the operation of nuclear facilities, aircraft navigation or communication systems, air traffic control, direct life support machines or weapons systems in which the failure of Software could lead directly to death, personal injury or severe physical or environmental damage ('High Risk Activities'). MikroElektronika and its suppliers specifically disclaim any expressed or implied warranty of fitness for High Risk Activities.

## TRADEMARKS

The MikroElektronika name and logo, mikroC™, mikroBasic™, mikroPascal™, Visual TFT™, Visual GLCD™, mikroProg™, Ready™, MINI™, mikroBUS™, EasyPIC™, EasyAVR™, Easy8051™, click™ boards and mikromedia™ are trademarks of MikroElektronika. All other trademarks mentioned herein are property of their respective companies. All other product and corporate names appearing in this manual may or may not be registered trademarks or copyrights of their respective companies, and are only used for identification or explanation and to the owners' benefit, with no intent to infringe.

*The STM32, ARM® and Windows® logos and product names are trademarks of STMicroelectronics®, ARM® Holdings and Microsoft® in the U.S.A. and other countries.*



- 
- If you want to learn more about our products, please visit our website at **[www.mikroe.com](http://www.mikroe.com)**
  - If you are experiencing some problems with any of our products or just need additional information, please place your ticket at **[www.mikroe.com/support](http://www.mikroe.com/support)**
  - If you have any questions, comments or business proposals, do not hesitate to contact us at **[office@mikroe.com](mailto:office@mikroe.com)**
- 

mikromedia 7 for STM32F4 manual  
ver 1.02a



Designed by  
MikroElektronika Ltd.