



MAX11105 Evaluation Kit

General Description

The MAX11105 evaluation kit (EV kit) is a fully assembled and tested PCB that evaluates the MAX11105 12-bit, SPI™-compatible, 2MSPS, analog-to-digital converter (ADC). The EV kit also includes Windows XP®, Windows Vista®, and Windows® 7-compatible software that provides a simple graphical user interface (GUI) for exercising the features of the device. The EV kit comes with a MAX11105AUT+ installed in a 6-pin SOT package.

Features

- ◆ 32MHz SPI Interface
- ◆ Windows XP, Windows Vista, and Windows 7-Compatible Software
- ◆ Time Domain, Frequency Domain, and Histogram Plotting in the EV Kit Software
- ◆ Frequency, RMS, Min, Max, and Average DC Calculations in the EV Kit Software
- ◆ Collects up to 1 Mega Samples
- ◆ On-Board Input Buffer
- ◆ USB-PC Connection
- ◆ Proven PCB Layout
- ◆ Fully Assembled and Tested

Ordering Information

PART	TYPE
MAX11105EVKIT+	EV Kit

+Denotes lead(Pb)-free and RoHS compliant.

Component List

DESIGNATION	QTY	DESCRIPTION
AIN_AC, AIN_DC, CS, DOUT, SCLK	5	White test points
AIN_AC_SMA, AIN_DC_SMA, 10MHZCLK	3	50Ω SMA female jacks
BUTTON, CPU_RESET, RECONFIGURE	3	Pushbutton switches
C1, C3	2	1000pF ±10%, 50V X7R ceramic capacitors (0603) Murata GRM188R71H102K
C2, C4, C31, C34, C36, C42, C43, C47, C55–C72, C78, C79, C80, C82, C84, C86	32	0.1μF ±10%, 25V X7R ceramic capacitors (0603) Murata GRM188R71E104K

DESIGNATION	QTY	DESCRIPTION
C5–C29	25	0.1μF ±10%, 16V X7R ceramic capacitors (0402) Murata GRM155R71C104K
C30, C95, C96, CB1, CB2, CB3	6	1μF ±10%, 16V X7R ceramic capacitors (0603) Murata GRM188R71C105K
C32	1	0.01μF ±10%, 16V X7R ceramic capacitor (0603) Murata GRM188R71C103K
C33, C38, C39, C40	4	4.7μF ±10%, 6.3V X5R ceramic capacitors (0603) Murata GRM188R60J475K
C35	1	1μF ±10%, 6.3V C0G ceramic capacitor (0805) Murata GRM21BR70J105K
C37, C41, C44, C45, C46, C48, C73, CP2, CP3	9	10μF ±10%, 6.3V X5R ceramic capacitors (0603) Murata GRM188R60J106M
C49, C53, C74, C99, C100	0	Not installed, ceramic capacitors (0603)

SPI is a trademark of Motorola, Inc.

Windows, Windows XP, and Windows Vista are registered trademarks of Microsoft Corp.



MAX11105 Evaluation Kit

Evaluates: MAX11105

Component List (continued)

DESIGNATION	QTY	DESCRIPTION
C54	0	Not installed, ceramic capacitor (through hole)
C75, C76	2	18pF ±5%, 50V C0G ceramic capacitors (0603) Murata GRM1885C1H180J
C77, C81	2	10µF ±20%, 10V capacitors (Tant B) KEMET T491B106M010AT
C83, C85	2	4.7µF ±20%, 25V capacitors (Tant B) AVX TAJB475M025R
C97	1	10µF ±10%, 10V X7R ceramic capacitor (0805) Murata GRM21BR71A106K
C98	0	Not installed, ceramic capacitor (0805)
CC1–CC4	4	10pF ±5%, 50V C0G ceramic capacitors (0603) Murata GRM1885C1H100J
CP1	1	100µF ±20%, 6.3V X5R ceramic capacitor (1210) Murata GRM32ER60J107M
GND	5	Black test points
J1	0	Not installed, 32-pin (2 x 16) header
J2	1	USB type-B, right-angle PC-mount receptacle
JTAG1, JTAG2	0	Not installed, headers
JU1–JU4, JU12, JU13, JU14, JU16, JU18	9	3-pin headers
JU5–JU8, JU17, JU19, JU20	7	2-pin headers
JUC1–JUC7	0	Not installed, 3-pin headers—shorted with PCB trace
L1	1	Ferrite bead (0603) TDK MMZ1608R301A

DESIGNATION	QTY	DESCRIPTION
L3	0	Not installed, inductor—shorted with PCB trace (1206)
LED1–LED4	4	Red LEDs (0603)
OP+, VDD, VIN	3	Red test points
OP-	1	Brown test point
R1, R2, R5, R6, R7	5	100kΩ ±5% resistors (0603)
R3, R4, R39, R40	4	1kΩ ±5% resistors (through hole)
R10, R33	2	22Ω ±5% resistors (0603)
R11–R21	11	5.1kΩ ±5% resistors (0603)
R22–R25, R28, R34, R35, R41	8	10kΩ ±1% resistors (0603)
R26	1	16.5kΩ ±1% resistor (0603)
R27	1	4.42kΩ ±1% resistor (0603)
R29	1	20kΩ ±1% resistor (0603)
R30, RC1–RC7	8	10kΩ ±5% resistors (0603)
R31, R37	0	Not installed, resistors (0603)
R32	1	12.1kΩ ±1% resistor (0603)
R36	1	0Ω ±5% resistor (0603)
R42	1	10Ω ±1% resistor (0603)
RC8, RC9, RC10	3	1kΩ ±5% resistors (0603)
RL1–RL4	4	120Ω ±5% resistors (0603)
RN14–RN21	8	22Ω, 8-pin SMT resistor networks
RN22	1	5.1kΩ, 8-pin SMT resistor network
RN25	1	10kΩ, 8-pin SMT resistor network
RSENSE1	1	0.1Ω ±1%, 1/2W sensing resistor (1206)
S1	1	4-position SMT half-pitch DIP switch
U1	1	12-bit, 3Msps ADC (6 SOT23) Maxim MAX11105AUT+
U2	1	Cyclone III FPGA Altera EP3C25F324C8N
U5	1	256Kx36 SSRAM (100 TQFP) ISSI IS61LPS25636A-200TQLI

MAX11105 Evaluation Kit

Evaluates: MAX11105

Component List (continued)

DESIGNATION	QTY	DESCRIPTION
U6	0	Not installed, 32Mx16 Flash (64 EBGA) Numonyx/Intel PC28F256P30BFA
U7	1	EPCS16 (8 SO) Altera EPCS16SI8N
U8	1	Current sensor (8 μ MAX [®]) Maxim MAX9929FAUA+
U9	1	Input buffer (5 SOT23) Maxim MAX4430EUK+
U10, U11, U12	3	LDOs (16 TSSOP-EP*) Maxim MAX1793EUE50+
U13	1	LDO (6 SOT23) Maxim MAX1983EUT+

DESIGNATION	QTY	DESCRIPTION
U14	1	SRAM (48 TSOP) Cypress CY62167DV30LL-55ZXI
U15	1	USB PHY (SOT617-1) ST Ericsson ISP1504ABS
U18, U19	2	Dual buffers (6 SC70)
Y1	1	50MHz oscillator
Y2	1	19.2MHz, 18pF SMD crystal
—	1	USB high-speed A-to-B cables, 6ft
—	16	Shunts
—	1	PCB: MAX11105 EVALUATION KIT+

*EP = Exposed pad.

Component Suppliers

SUPPLIER	PHONE	WEBSITE
Altera Corp.	800-800-3753	www.altera.com
AVX Corporation	843-946-0238	www.avxcorp.com
KEMET Corp.	864-963-6300	www.kemet.com
Murata Electronics North America, Inc.	770-436-11105	www.murata-northamerica.com
TDK Corp.	847-803-6100	www.component.tdk.com

Note: Indicate that you are using the MAX11105 when contacting these component suppliers.

MAX11105 EV Kit Files

FILE	DESCRIPTION
INSTALL.EXE	Installs the EV kit files on your computer
MAX11105.EXE	Application program
SLSUSB.DLL	Software library file
SLSUSB.INF	USB device driver file
SLSUSB.SYS	USB device driver file
USB_Driver_Help_200.PDF	USB driver installation file

μ MAX is a registered trademark of Maxim Integrated Products, Inc.

MAX11105 Evaluation Kit

Quick Start

Required Equipment

- MAX11105 EV kit
- +5.5V, 500mA DC power supply
- Windows XP, Windows Vista, or Windows 7 PC with a spare USB port
- Function generator

Note: In the following sections, software-related items are identified by bolding. Text in **bold** refers to items directly from the EV kit software. Text in **bold and underlined** refers to items from the Windows operating system.

Procedure

The EV kit is fully assembled and tested. Follow the steps below to verify board operation. **Caution: Do not turn on the power supply until all connections are completed.**

- 1) Uncompress the 11105Rxx.ZIP file in a temporary folder.
- 2) Install the EV kit software on your computer by running the INSTALL.EXE program inside the temporary folder. The program files are copied to your PC and icons are created in the Windows **All Programs** menu. During software installation, some versions of Windows may show a warning message indicating that this software is from an unknown publisher. This is not an error condition and it is safe to proceed with installation. Administrator privileges are required to install the software on Windows.
- 3) Verify that all jumpers are in their default positions, as shown in Table 1.
- 4) Connect the positive terminal of the +5.5V power supply to the VIN connector on the board. Connect the negative terminal of the same power supply to the GND connector on the board.
- 5) Set the signal source to generate a 100kHz, +1V peak-to-peak sinusoidal wave with +2V offset.
- 6) Connect the positive terminal of the function generator to the AIN_DC or AIN_DC_SMA connector. Connect the negative terminal of the function generator to the GND connector.
- 7) Turn on the power supply.
- 8) Turn on the function generator.
- 9) Connect the USB cable from the PC to the EV kit board. Follow the instructions on the SLS_USB_Driver_Help_100.pdf file to manually install the USB driver. Administrative privileges are required to install the USB device driver on Windows.
- 10) Start the EV kit software by opening its icon in the Windows **All Programs** menu. The EV kit software main window appears, as shown in Figure 1.
- 11) The main windows should display **Hardware Connected** in the bottom-left corner.
- 12) Check the **Remove DC** checkbox.
- 13) Press the **Start Conversion** button.
- 14) Verify that the **Frequency** displayed in the **Calculation** group box reads approximately 100000Hz.

MAX1105 Evaluation Kit

Evaluates: MAX1105

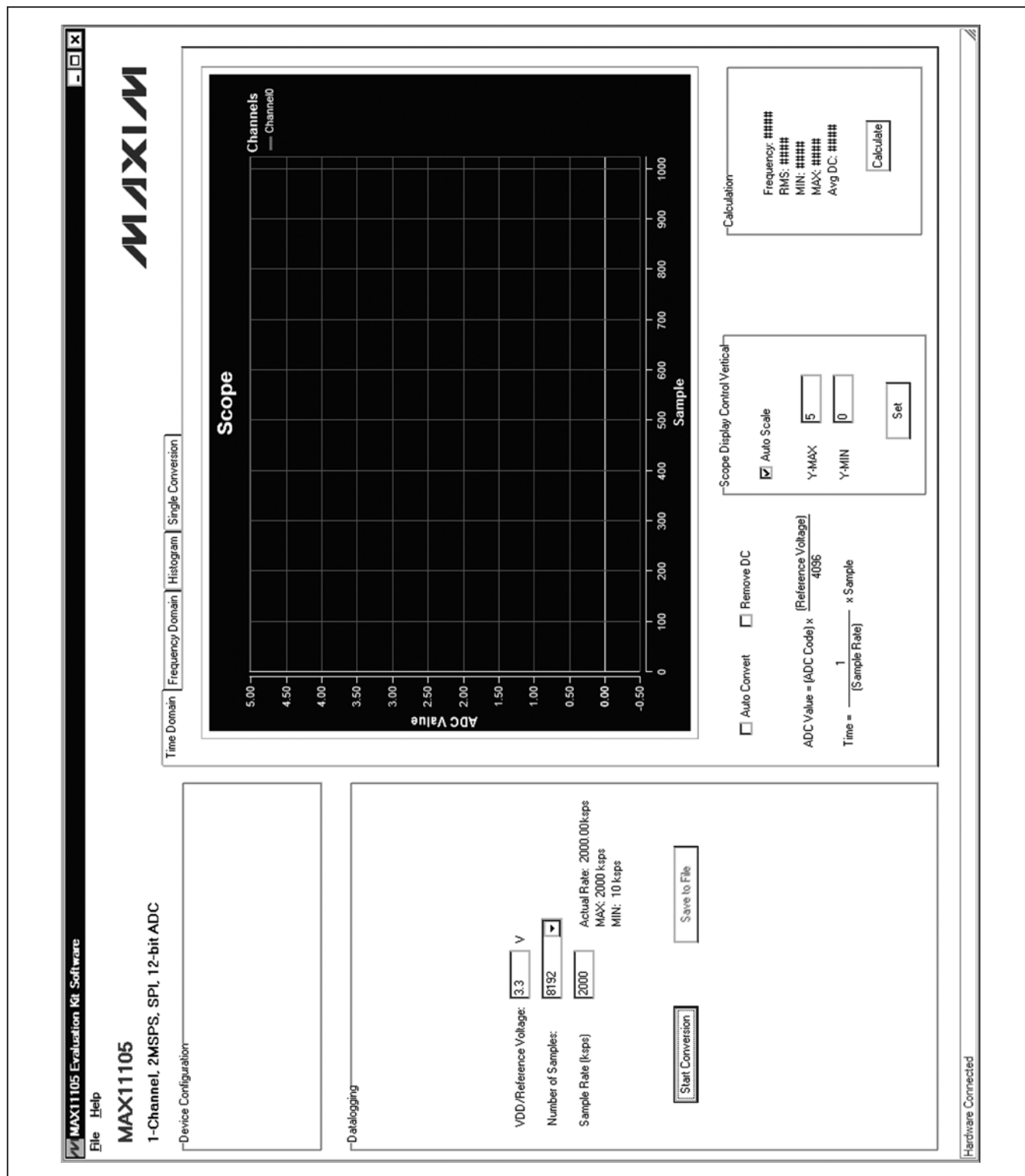

Figure 1. MAX1105 EV Kit Software Main Window

MAX11105 Evaluation Kit

__Detailed Description of Software

The main window of the evaluation software (Figure 1) contains a **Datalogging** group box and four tabs to display the sampled data.

Data Logging

In the **Datalogging** group box, the user can select the desired number of conversions from the **Number of Samples** drop-down list. Enter the desired sampling rate in the **Sample Rate (ksps)** edit box. The actual sampling rate is displayed at the right of the **Sample Rate (ksps)** edit box. Press the **Start Conversion** button to start sampling. After sampling is finished, the user can save the data to a file by pressing the **Save to File** button. The **Save to File** button is not active until the sampling is done.

Time Domain, Frequency Domain, Histogram, and Single Conversion Tabs

After the **Start Conversion** button in the **Datalogging** group box is pressed, the sampled data in the time domain is plotted in the **Time Domain** tab sheet. The sampled data in the frequency domain is plotted in the **Frequency Domain** tab sheet and the histogram of the sampled signal is plotted in the **Histogram** tab sheet. The **Single Conversion** tab sheet displays one sampled data.

Check the **Auto Convert** checkbox to automatically and repeatedly perform the ADC conversions and update the active tab sheet.

Time Domain Tab

In the **Time Domain** tab sheet (Figure 2), check the **Remove DC** checkbox to remove the DC component of the sampled signal. When the **Auto Scale** checkbox in the **Scope Display Control Vertical** group

box is checked, the software automatically scales the vertical axis in the plot. If the **Auto Scale** checkbox is unchecked, enter the appropriate values into the **Y-MAX** and **Y-MIN** edit boxes and press the **Set** button to set the boundaries for the vertical axis. The software automatically calculates the **Frequency**, **RMS**, **MIN**, **MAX**, and **Avg DC** of the sampled signal and displays the calculated values in the **Calculation** group box.

Frequency Domain Tab

The **Frequency Domain** tab sheet (Figure 3) displays the FFT plot of the signal shown in the **Time Domain** tab sheet.

Histogram Tab

The **Histogram** tab sheet (Figure 4) displays the histogram of the signal shown in the **Time Domain** tab sheet. The software automatically calculates the **Mean** and the **Std Dev** (standard deviation, sigma) and displays the calculated values in the **Calculation** group box.

The **Histogram Display Control** radio group box provides three options to scale the horizontal axis on the histogram:

- 1) **(Mean – 3 sigma) to (Mean + 3 sigma)**
- 2) **(Mean – 6 sigma) to (Mean + 6 sigma)**
- 3) User-defined range (**MIN**, **MAX**)

Single Conversion

The **ADC Value Display** group box in the **Single Conversion** tab sheet (Figure 5) displays the **ADC Code** and calculated **Voltage** values for a single sample. Press the **Start Conversion** button in the **Datalogging** group box to update the status of the **ADC Value Display** group box.

MAX1105 Evaluation Kit

Evaluates: MAX1105

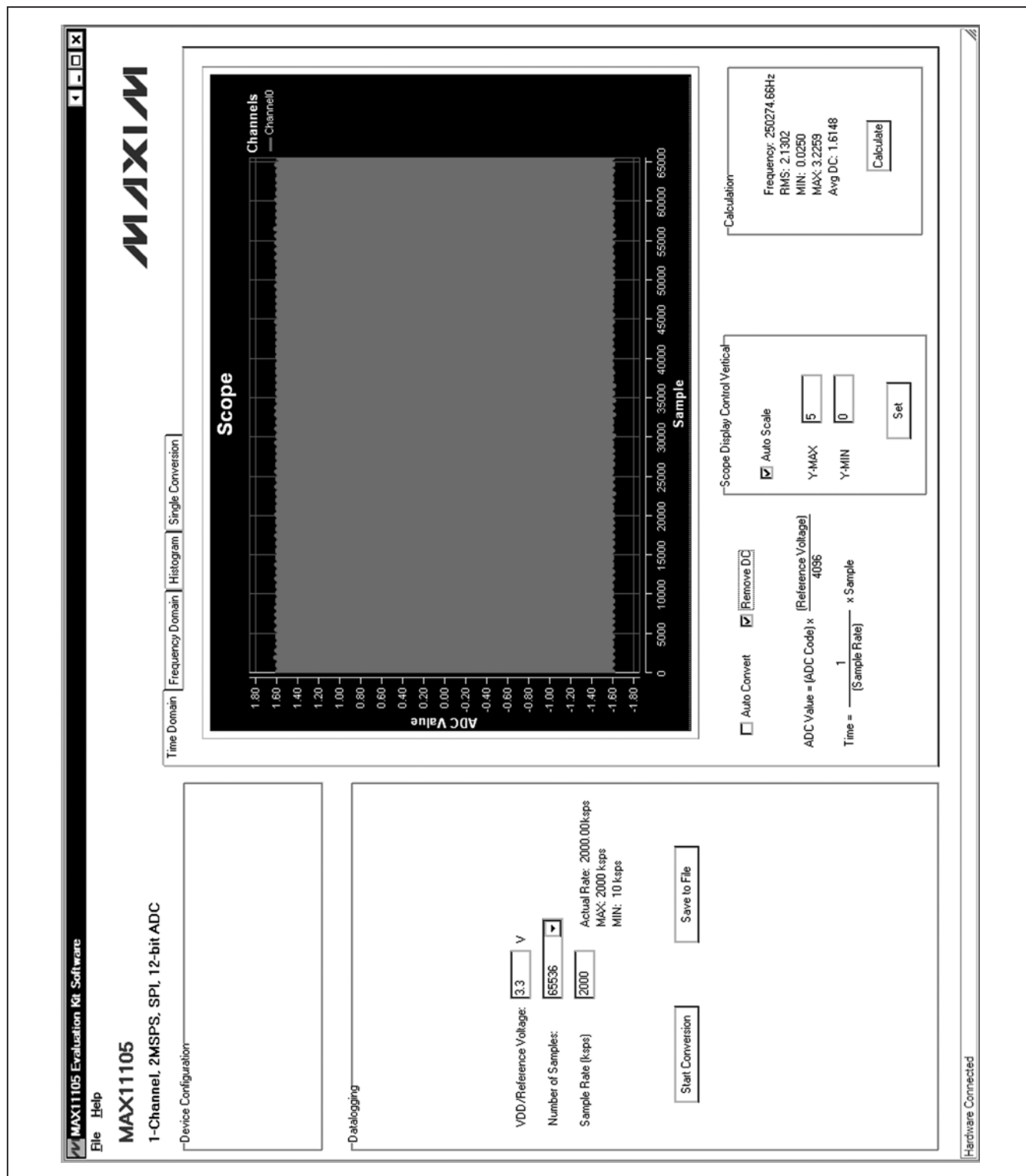

Figure 2. Time Domain Tab

MAX11105 Evaluation Kit

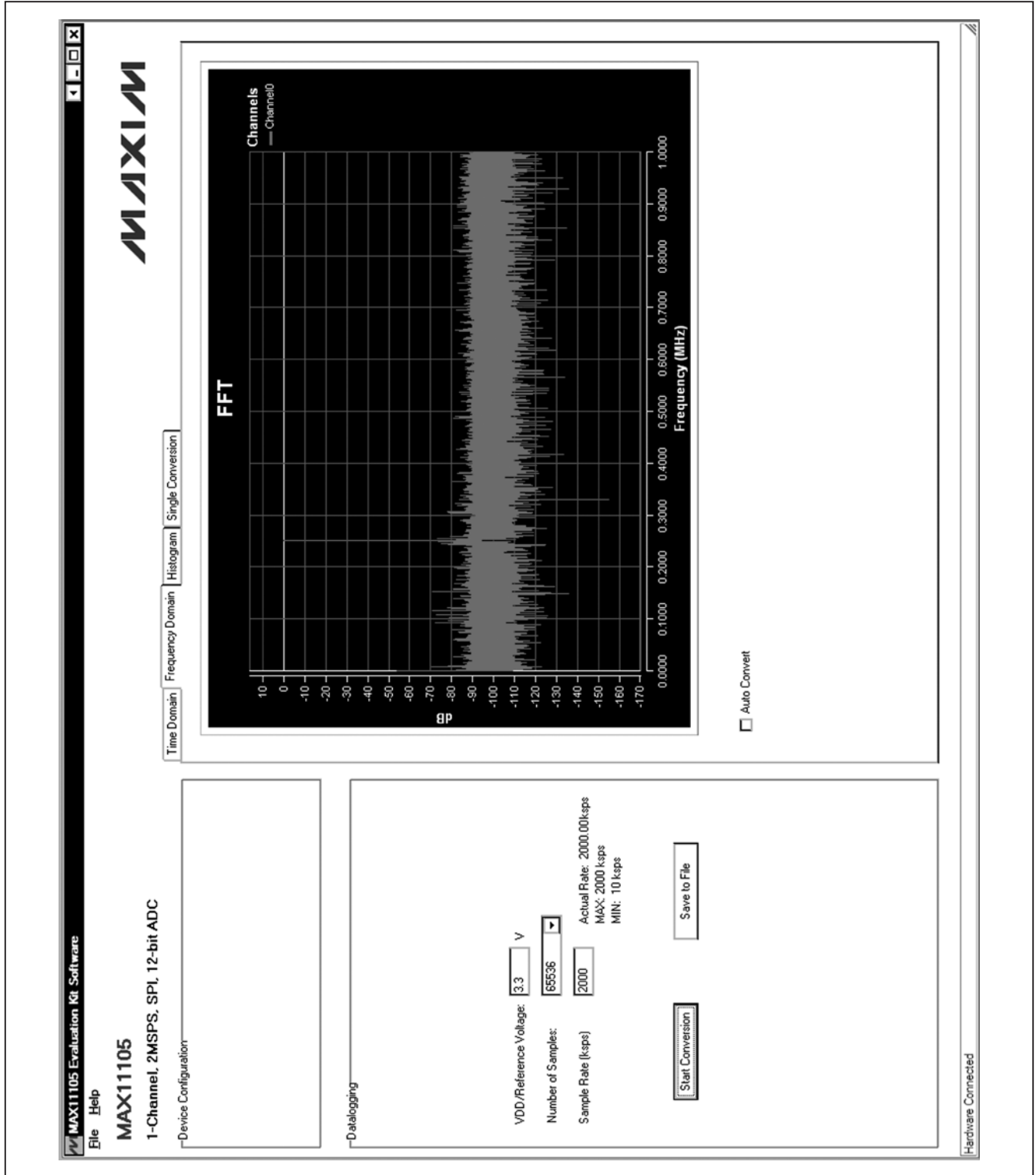

Figure 3. Frequency Domain Tab

MAX1105 Evaluation Kit

Evaluates: MAX1105

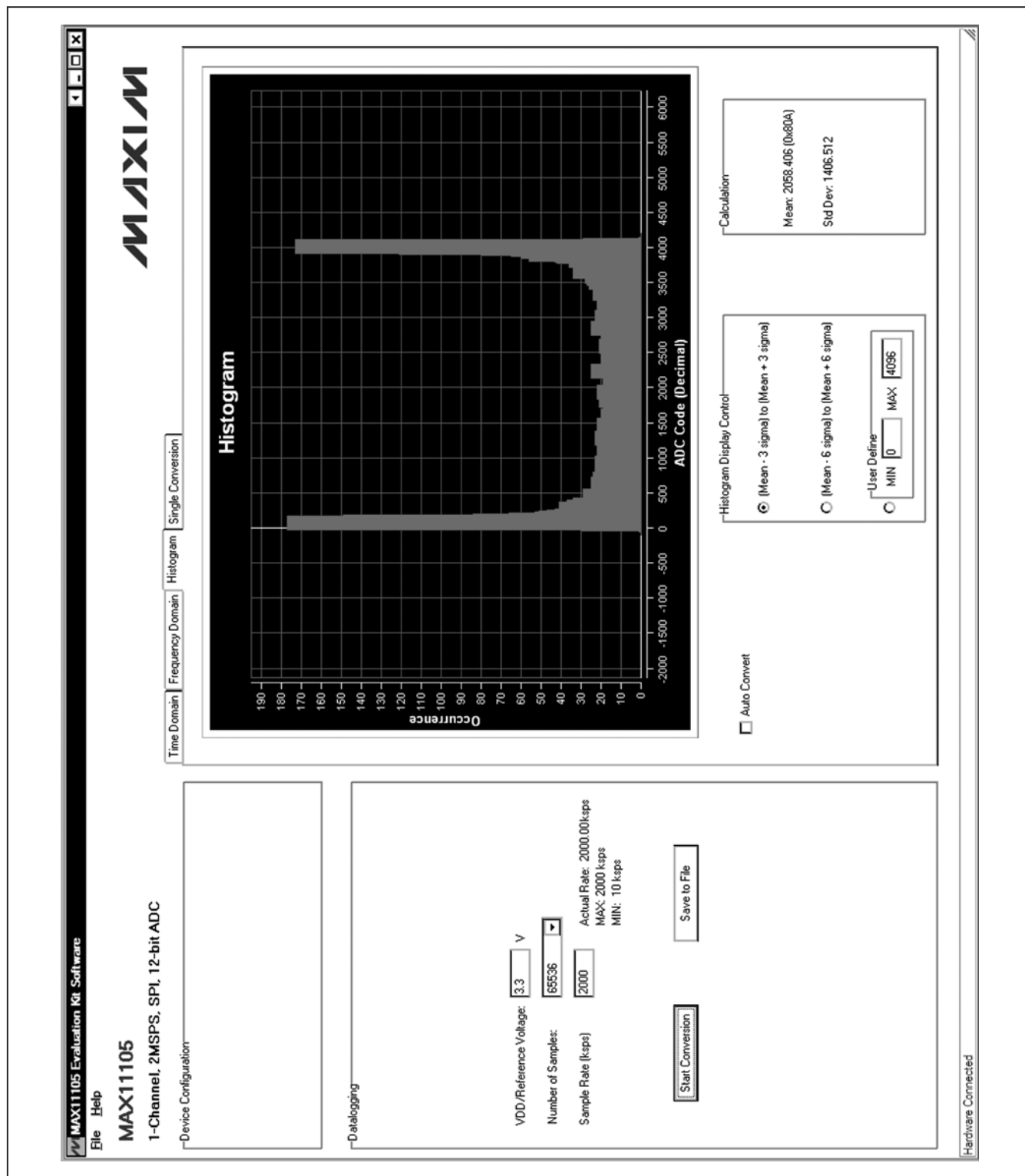

Figure 4. Histogram Tab

MAX11105 Evaluation Kit

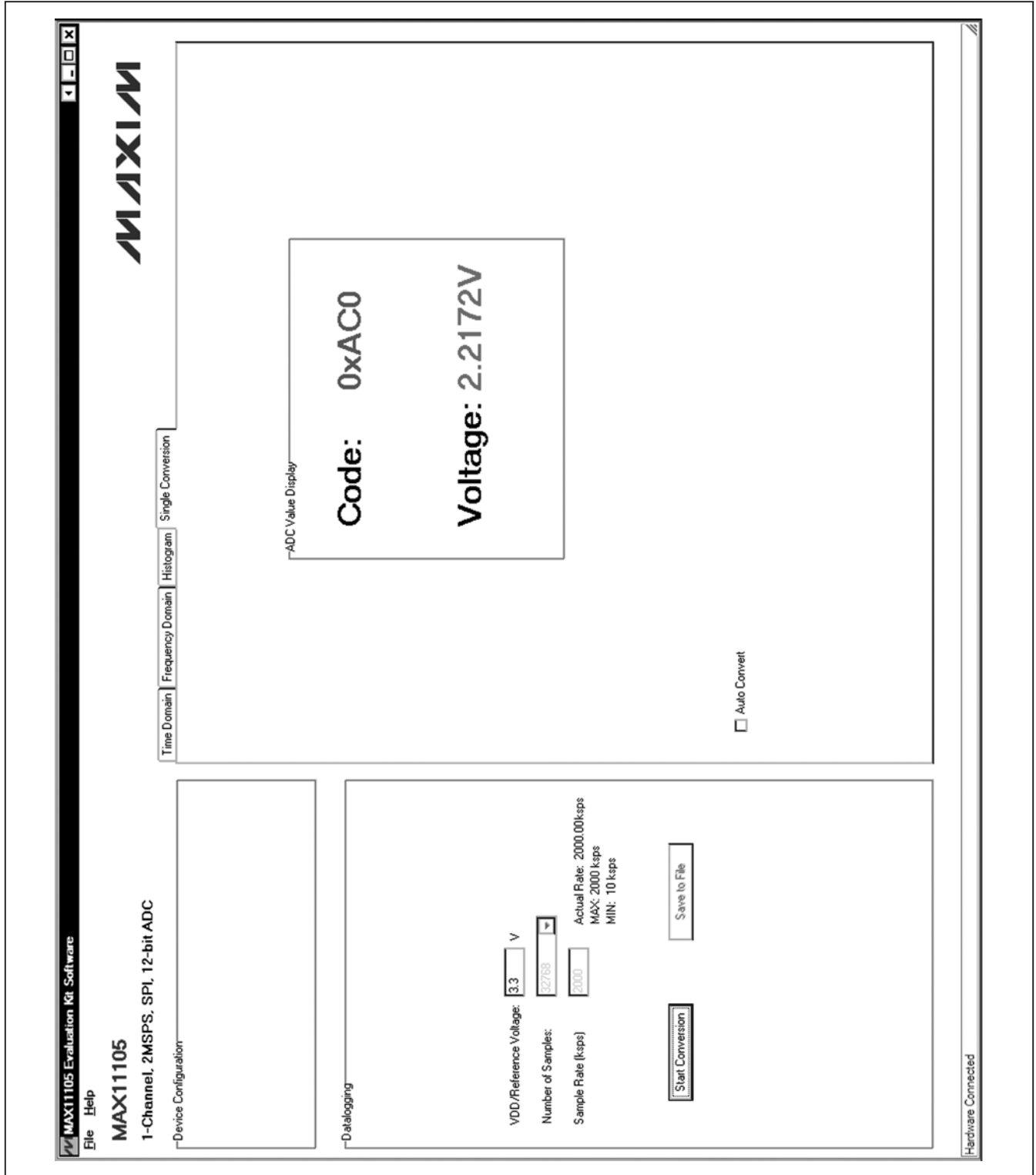

Figure 5. Single Conversion Tab

MAX11105 Evaluation Kit

Evaluates: MAX11105

Detailed Description of Hardware

The MAX11105 EV kit is a fully assembled and tested PCB that evaluates the MAX11105 12-bit, SPI-compatible 2Msps ADC. The EV kit comes with a MAX11105AUT+ in a 6-pin SOT package installed.

Power Supply

A +5.5V power supply is required to power up the EV kit. Connect the positive terminal of the power supply to the VIN connector and the negative terminal to the GND connector.

On-Board Input Buffer

An on-board input buffer (U9) is provided on the EV kit. Connect the +5V, GND, and -5V terminals of the power supply to the OP+, GND, and OP- connectors, respectively, to power the on-board buffer.

Move the shunt of JU18 to the 2-3 position and remove the shunts on JU19 and JU20. The user can connect

the AC signal to the AIN_AC_SMA or the AIN_AC connector and connect the DC offset to the AIN_DC_SMA or the AIN_DC connector. If the measuring signal has already been shifted above the ground level, short the AC input to ground by installing a shunt on JU19, and connect the measuring signal to the AIN_DC_SMA or the AIN_DC connector. To bypass the buffer and connect the measuring signal directly to the AIN input of the ADC, move the shunt on JU18 to the 1-2 position. Finally, connect the measuring signal to the AIN_DC_SMA or the AIN_DC connector.

User-Supplied SPI Interface

For a user-supplied SPI interface, first move the shunts on JU12, JU13, and JU14 to the 2-3 position and connect the user-supplied \overline{CS} , SCLK, and MISO signals to the corresponding \overline{CS} , SCLK, and DOUT connectors on the EV kit.

Table 1. Jumper Settings (JU1–JU8, JU12, JU13, JU14, JU16–JU20)

JUMPER	SHUNT POSITION	DESCRIPTION
JU1	1-2	Connects the USB power to the input of the on-board LDO (U10).
	2-3*	Connects the external power supply to the input of the on-board LDO (U10).
JU2	1-2	Connects the USB power to the input of the on-board LDO (U11).
	2-3*	Connects the external power supply to the input of the on-board LDO (U11).
JU3	1-2	Connects the USB power to the input of the on-board LDO (U12).
	2-3*	Connects the external power supply to the input of the on-board LDO (U12).
JU4	1-2	Connects the USB power to the input of the on-board LDO (U13).
	2-3*	Connects the external power supply to the input of the on-board LDO (U13).
JU5	1-2*	The on-board LDO (U10) provides 3.3V output to the EV kit.
	Open	Disconnects the output of the on-board LDO (U10).
JU6	1-2*	The on-board LDO (U11) provides 1.8V output to the EV kit.
	Open	Disconnects the output of the on-board LDO (U11).
JU7	1-2*	The on-board LDO (U12) provides 2.5V output to the EV kit.
	Open	Disconnects the output of the on-board LDO (U12).
JU8	1-2*	The on-board LDO (U13) provides 1.2V output to the EV kit.
	Open	Disconnects the output of the on-board LDO (U13).
JU12	1-2*	Connects the SCLK signal of the ADC (U1) to the FPGA.
	2-3	Connects the SCLK signal of the ADC (U1) to the SCLK connector.
JU13	1-2*	Connects the \overline{CS} signal of the ADC (U1) to the FPGA.
	2-3	Connects the \overline{CS} signal of the ADC (U1) to the /CS connector.
JU14	1-2*	Connects the DOUT signal of the ADC (U1) to the FPGA.
	2-3	Connects the DOUT signal of the ADC (U1) to the DOUT connector.

MAX11105 Evaluation Kit

Evaluates: MAX11105

Table 1. Jumper Settings (JU1–JU8, JU12, JU13, JU14, JU16–JU20) (continued)

JUMPER	SHUNT POSITION	DESCRIPTION
JU16	1-2*	Connects the VDD input of the ADC (U1) to the output of the on-board 3.3V LDO.
	2-3	Connects the VDD input of the ADC (U1) to the VDD connector.
JU17	1-2	Connects OP- to GND.
	Open*	Disconnects OP- from GND.
JU18	1-2*	Bypasses the on-board input buffer. Connects the AIN_DC_SMA or the AIN_DC connector to the AIN input of the ADC (U1).
	2-3	Connects the AIN input of the ADC (U1) to the output of the on-board buffer (U9).
JU19	1-2	Shorts the AC-signal input to GND.
	Open*	Connects the signal from the AIN_AC_SMA connector to the inverting input of the on-board buffer (U9) through a 1kΩ resistor.
JU20	1-2	Shorts the DC signal input to GND.
	Open*	Connects the signal from the AIN_DC_SMA connector to the noninverting input of the on-board buffer (U9) through a 1kΩ resistor.

*Default position.

MAX11105 Evaluation Kit

Evaluates: MAX11105

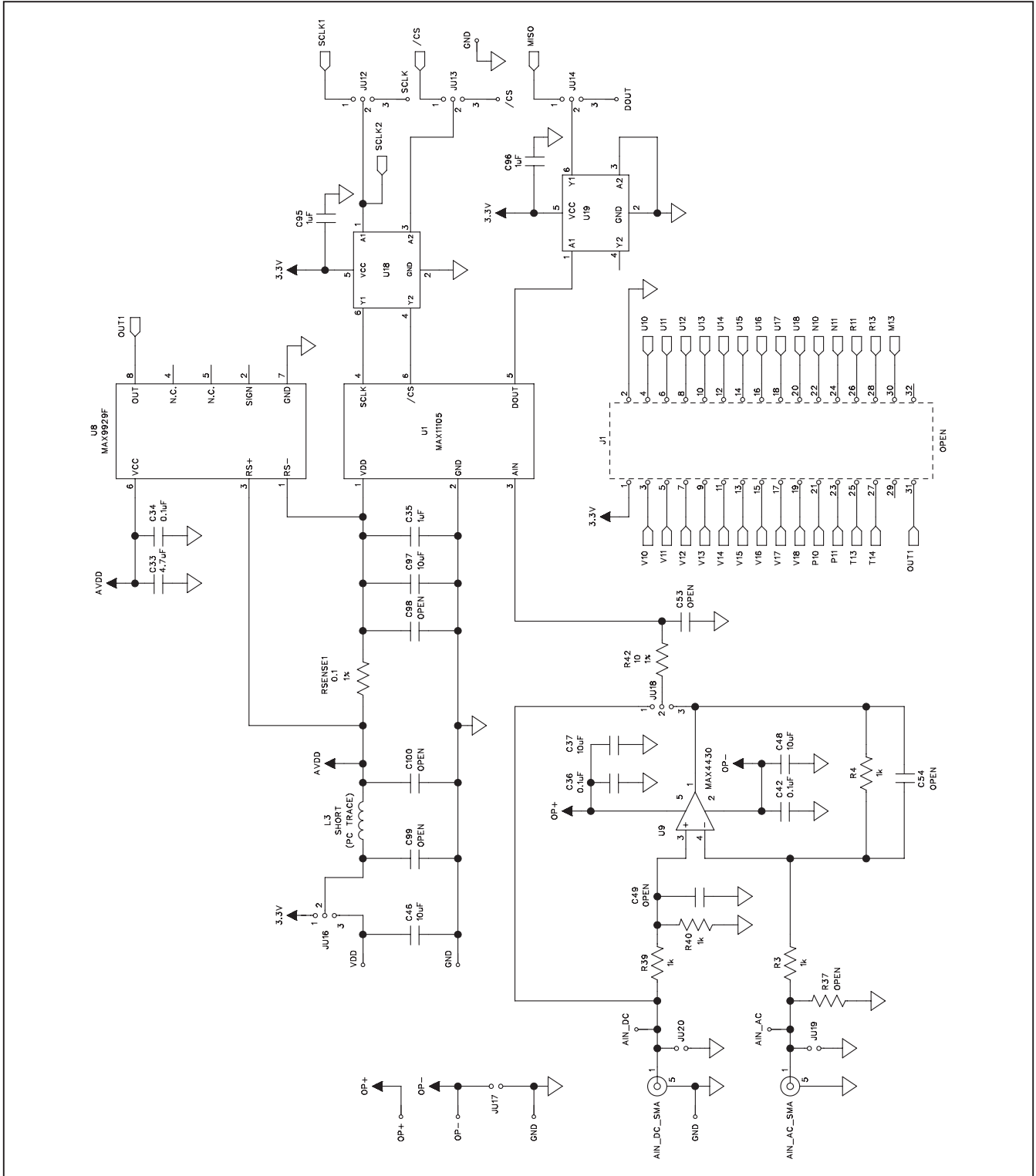

Figure 6a. MAX11105 EV Kit Schematic (Sheet 1 of 12)

MAX11105 Evaluation Kit

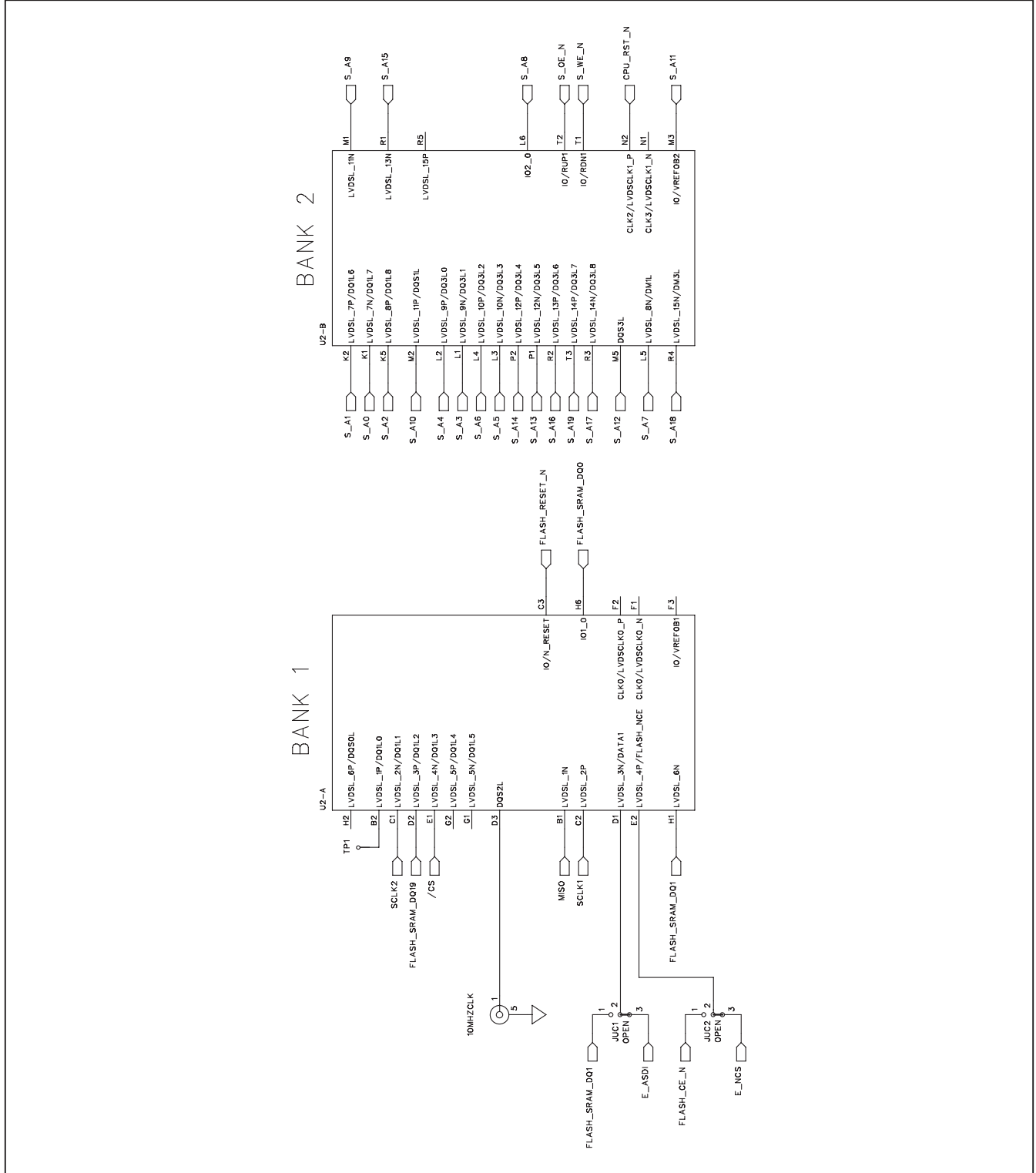

Figure 6b. MAX11105 EV Kit Schematic (Sheet 2 of 12)

MAX11105 Evaluation Kit

Evaluates: **MAX11105**

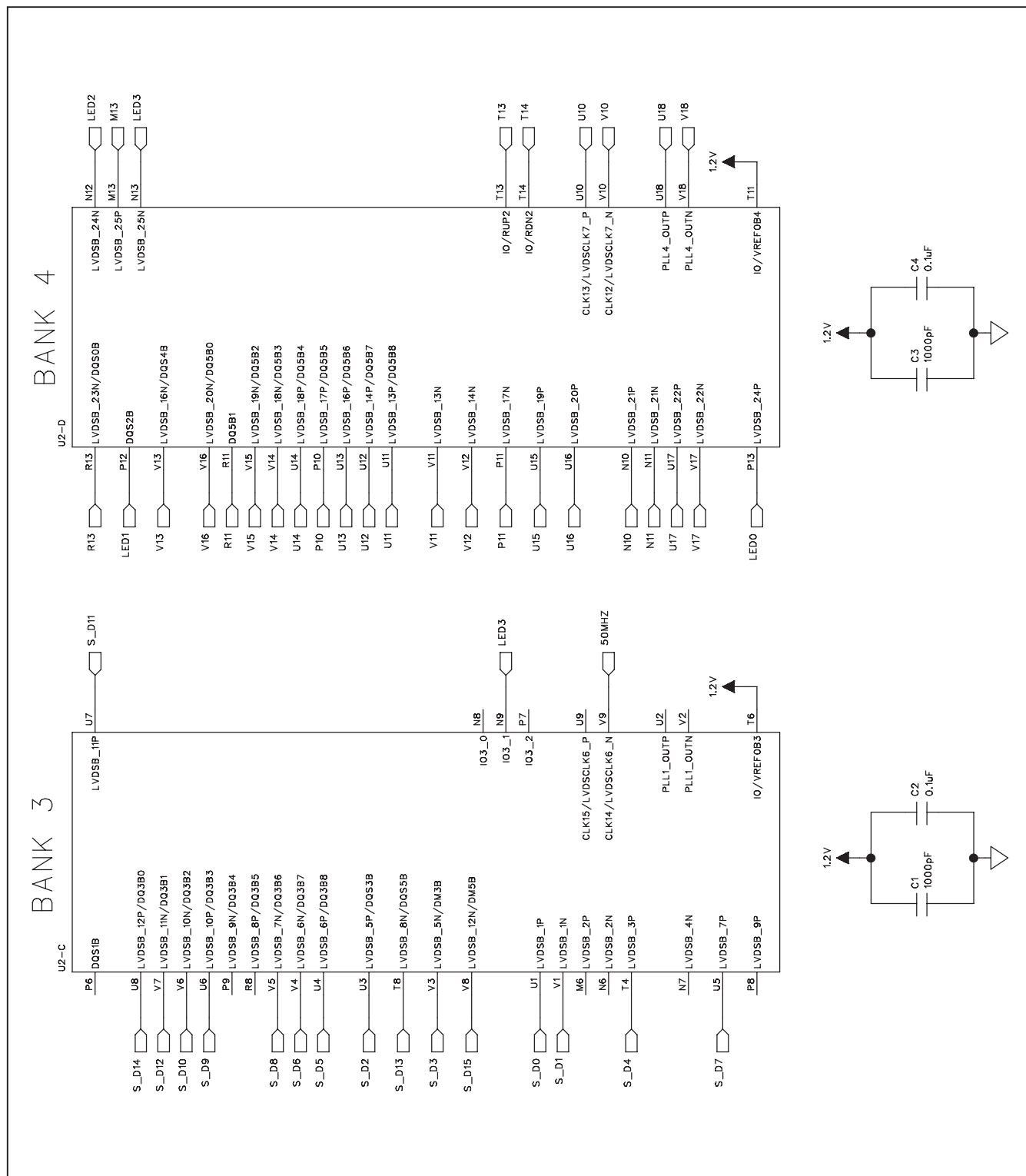

Figure 6c. MAX11105 EV Kit Schematic (Sheet 3 of 12)

MAX11105 Evaluation Kit

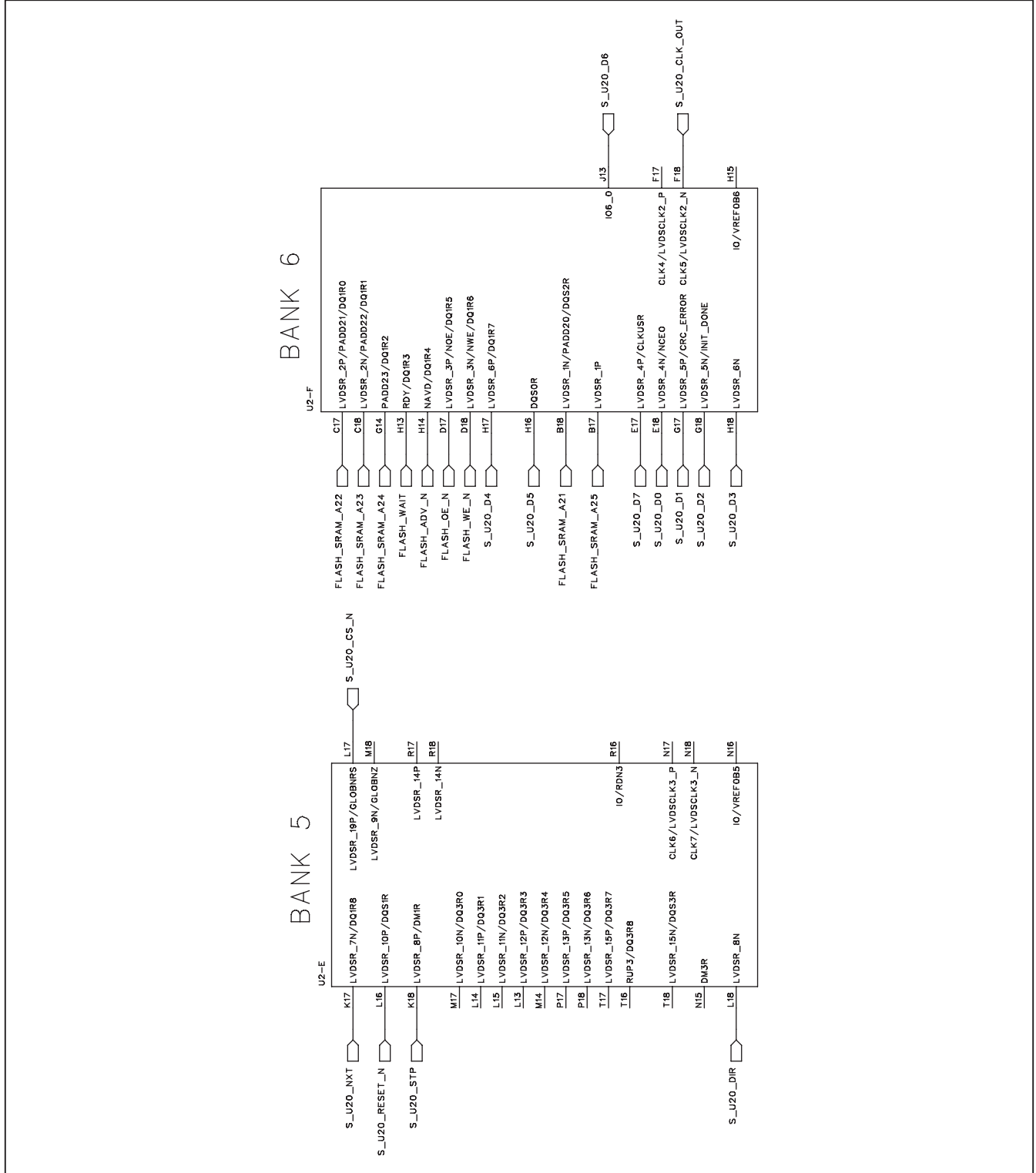

Figure 6d. MAX11105 EV Kit Schematic (Sheet 4 of 12)

MAX11105 Evaluation Kit

Evaluates: MAX11105

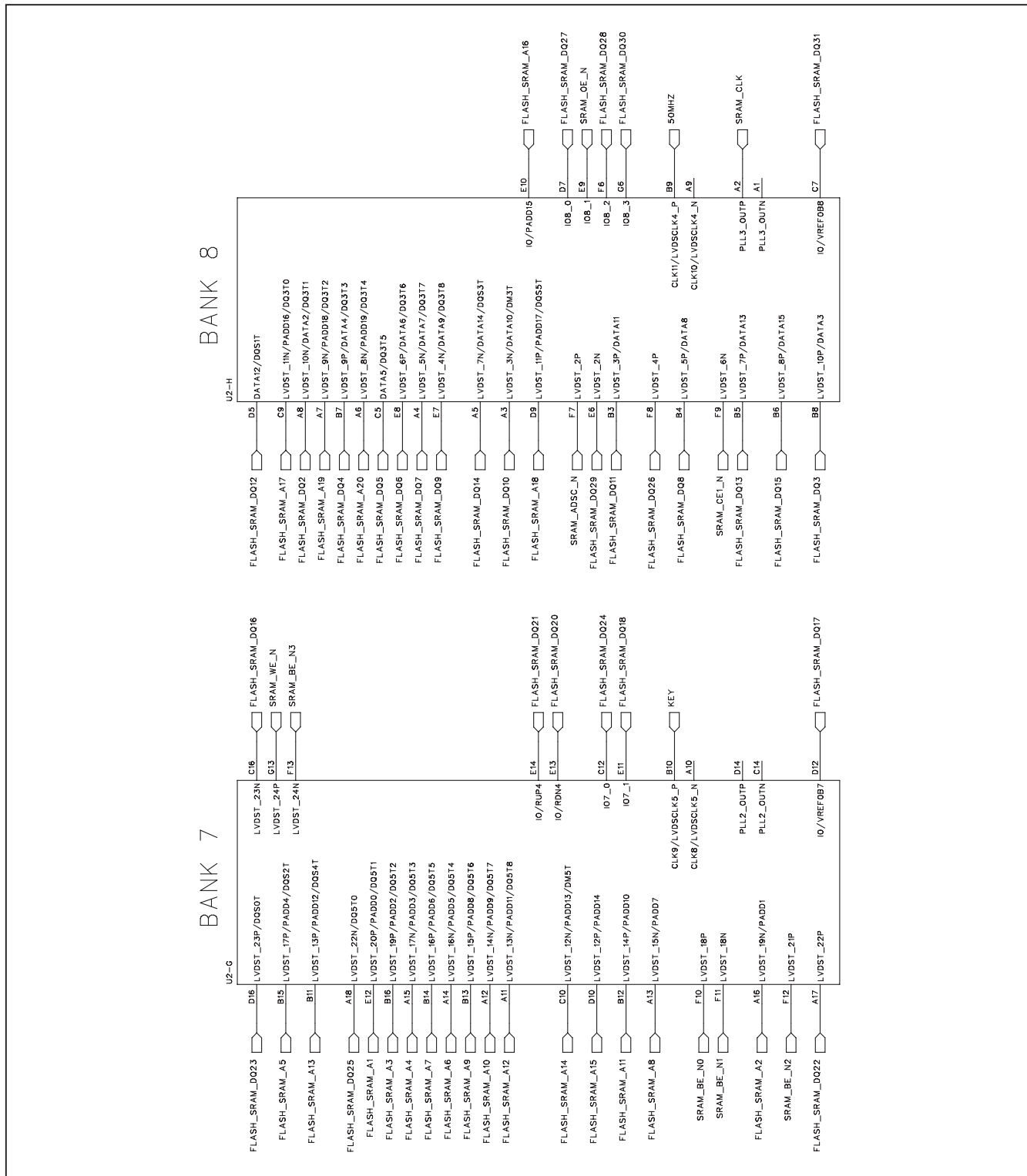

Figure 6e. MAX11105 EV Kit Schematic (Sheet 5 of 12)

MAX11105 Evaluation Kit

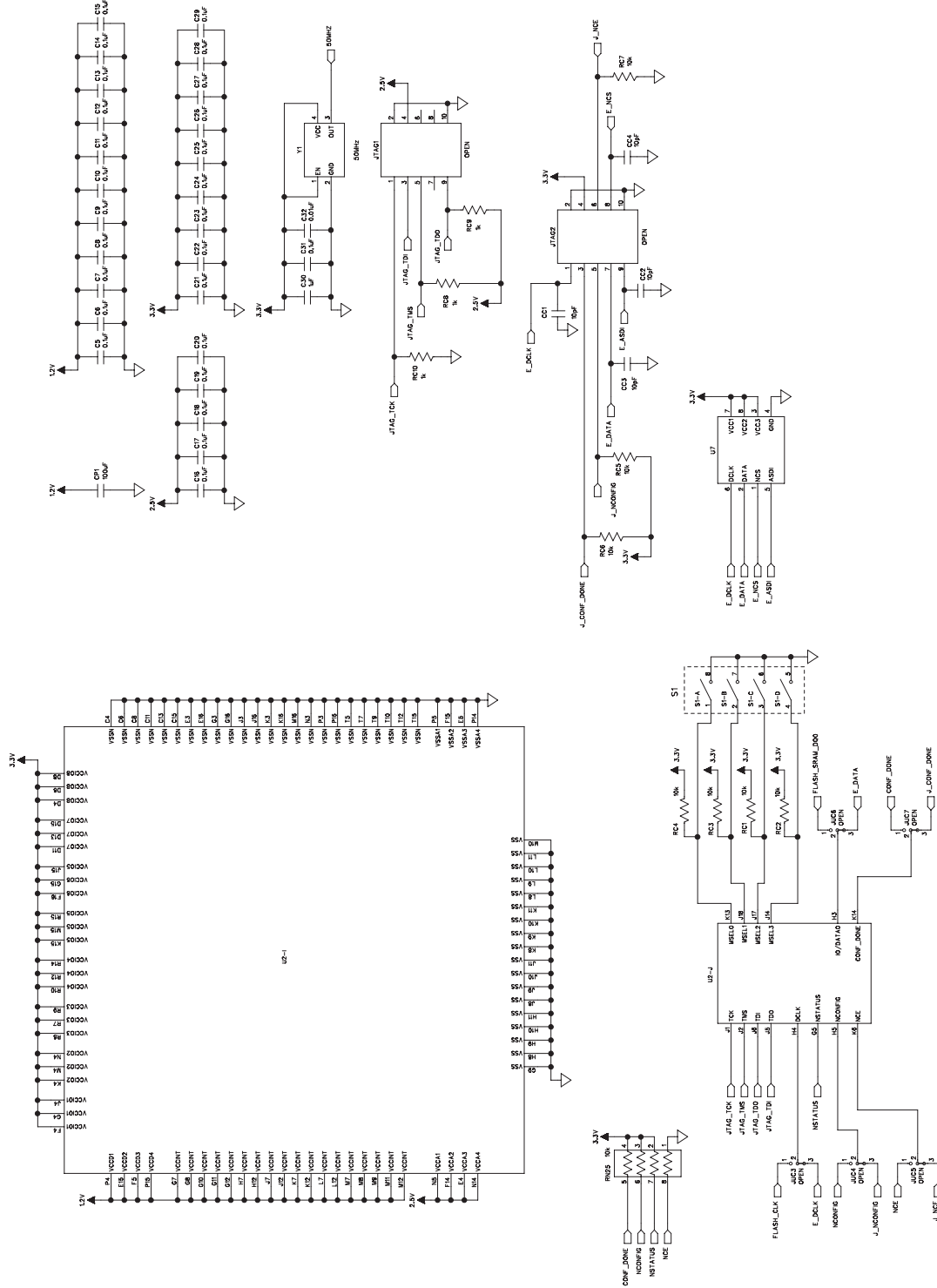

Figure 6f. MAX11105 EV Kit Schematic (Sheet 6 of 12)

MAX1105 Evaluation Kit

Evaluates: MAX11105

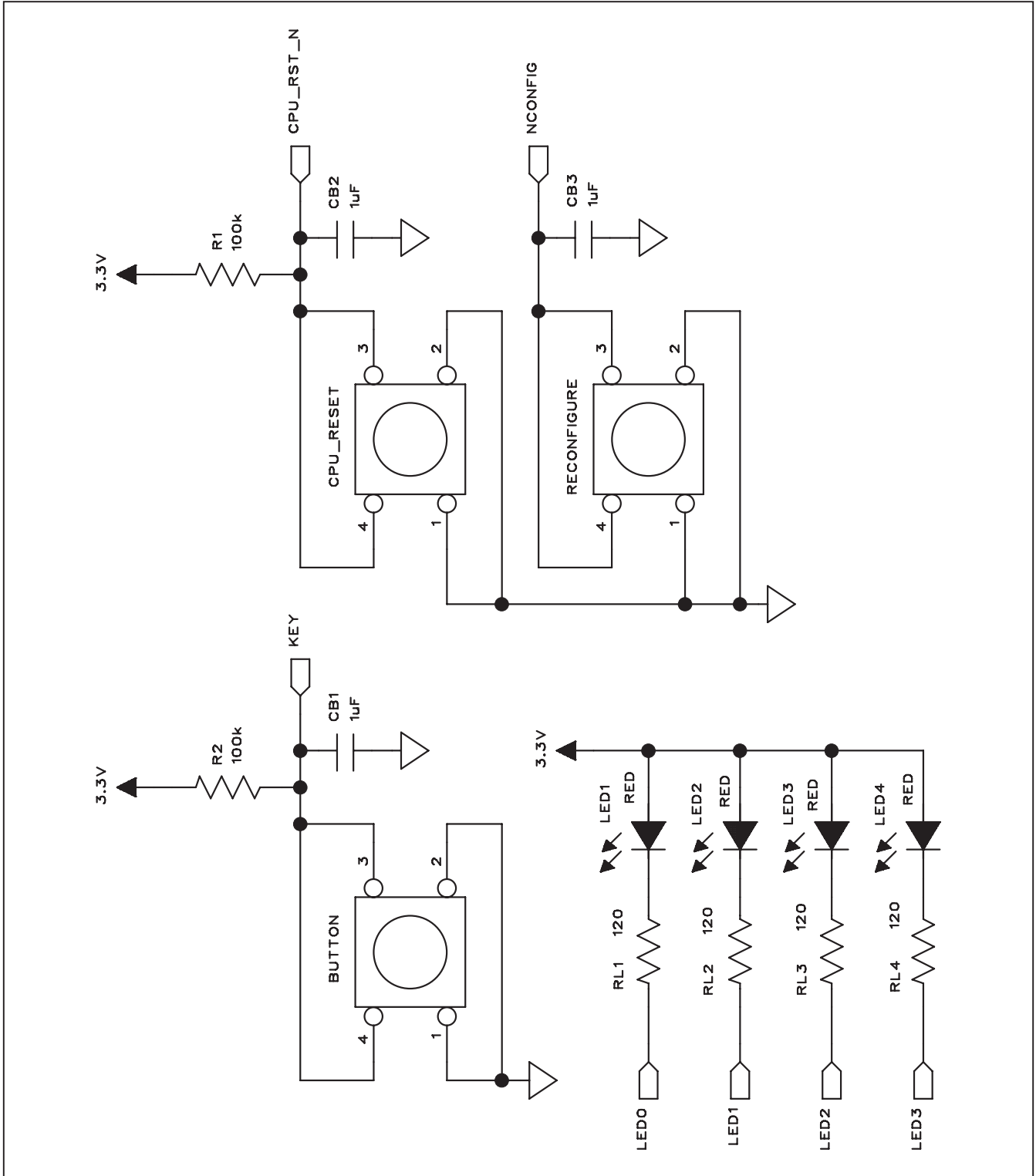

Figure 6g. MAX11105 EV Kit Schematic (Sheet 7 of 12)

MAX1105 Evaluation Kit

Evaluates: MAX1105

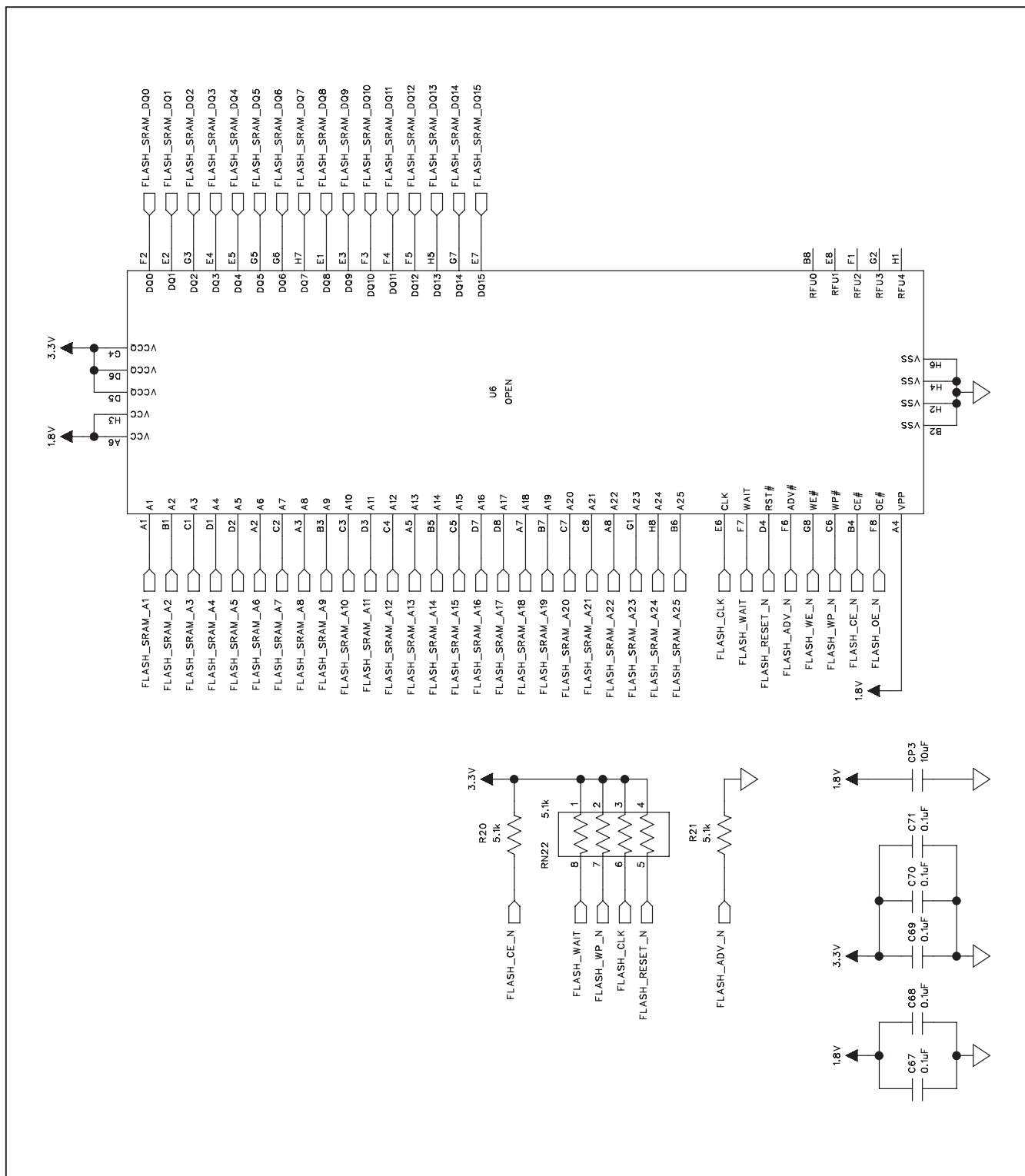

Figure 6i. MAX1105 EV Kit Schematic (Sheet 9 of 12)

Evaluates: MAX11105

MAX11105 Evaluation Kit

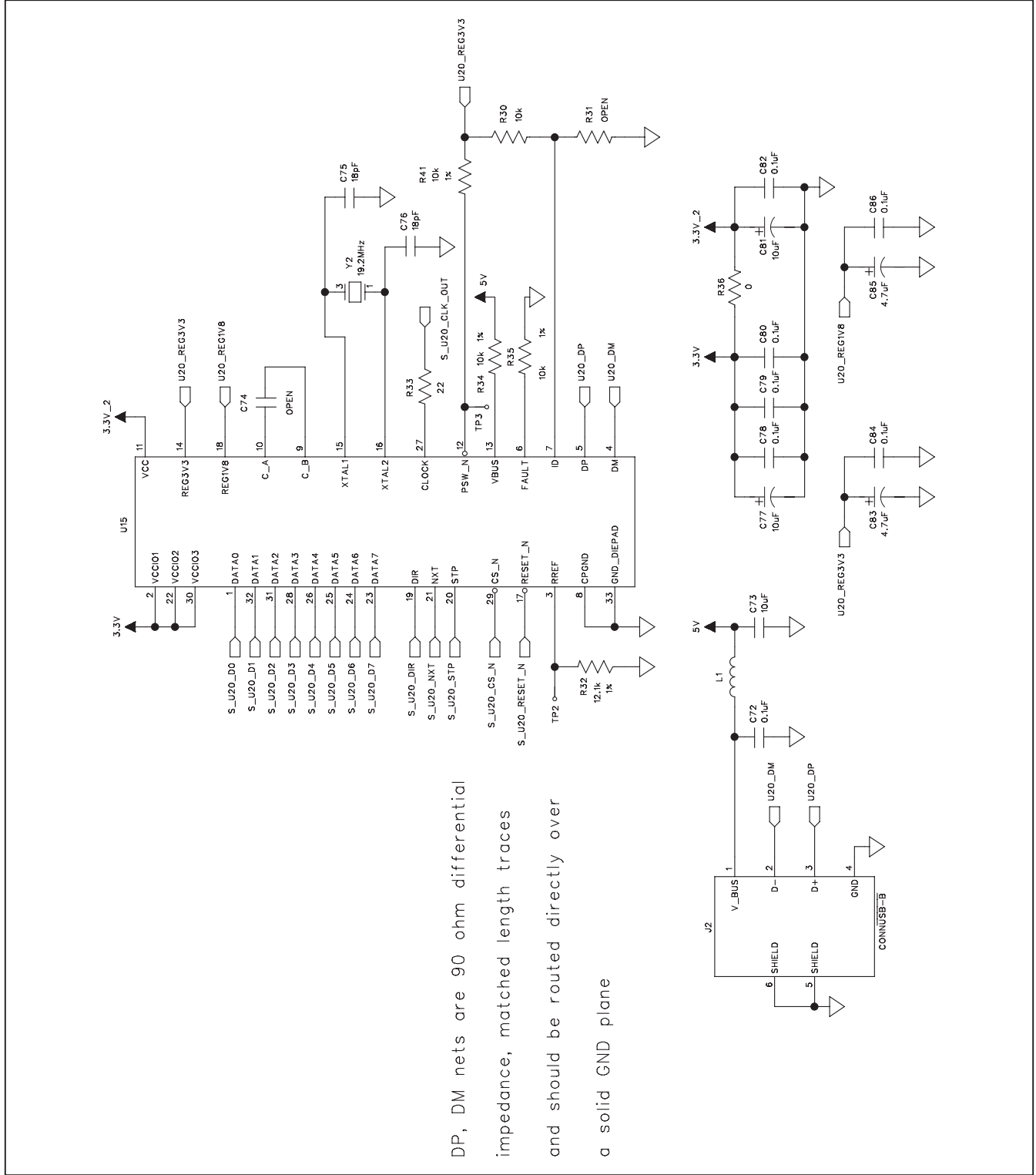

Figure 6j. MAX11105 EV Kit Schematic (Sheet 10 of 12)

MAX1105 Evaluation Kit

Evaluates: MAX1105

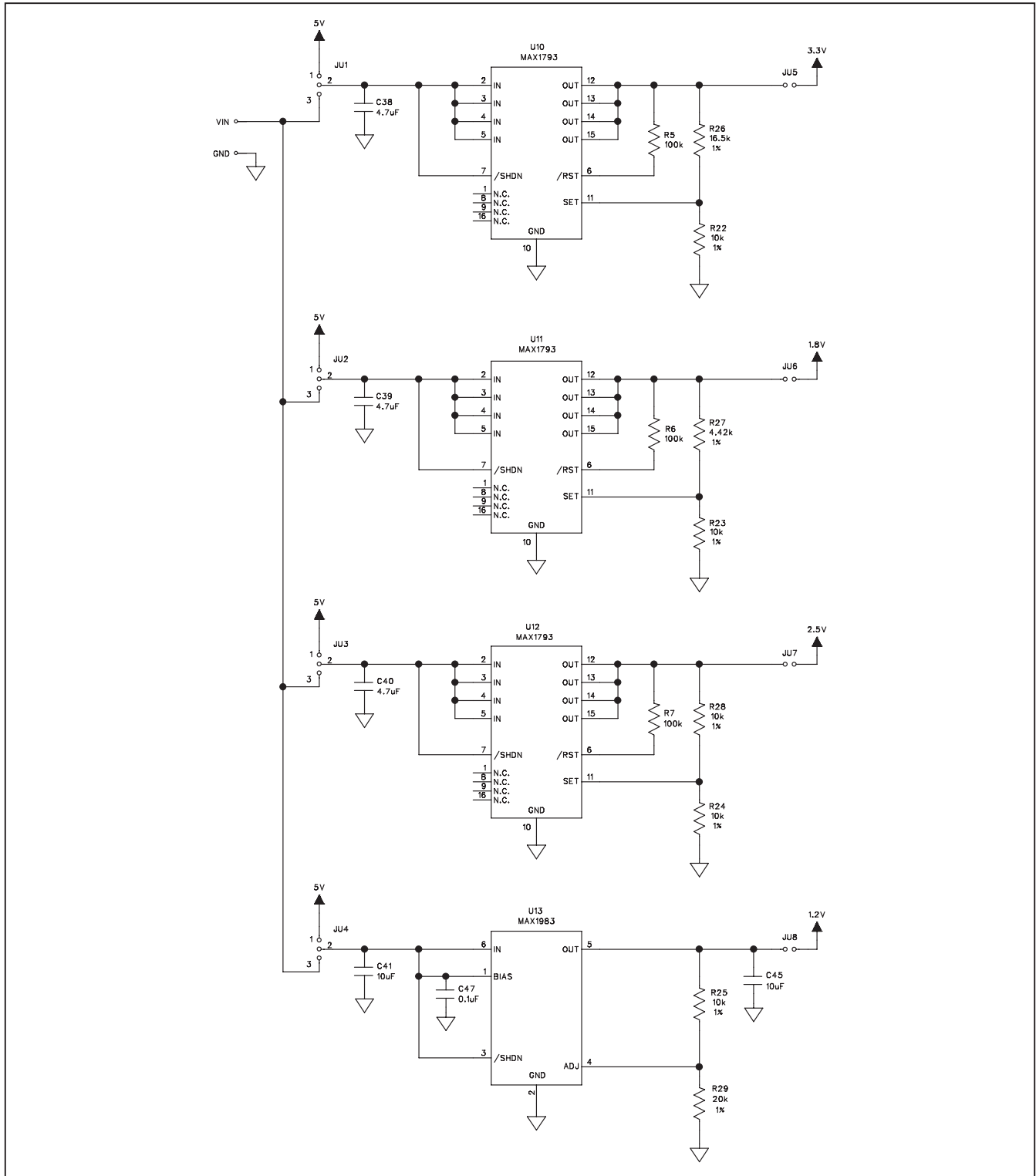

Figure 6k. MAX1105 EV Kit Schematic (Sheet 11 of 12)

MAX11105 Evaluation Kit

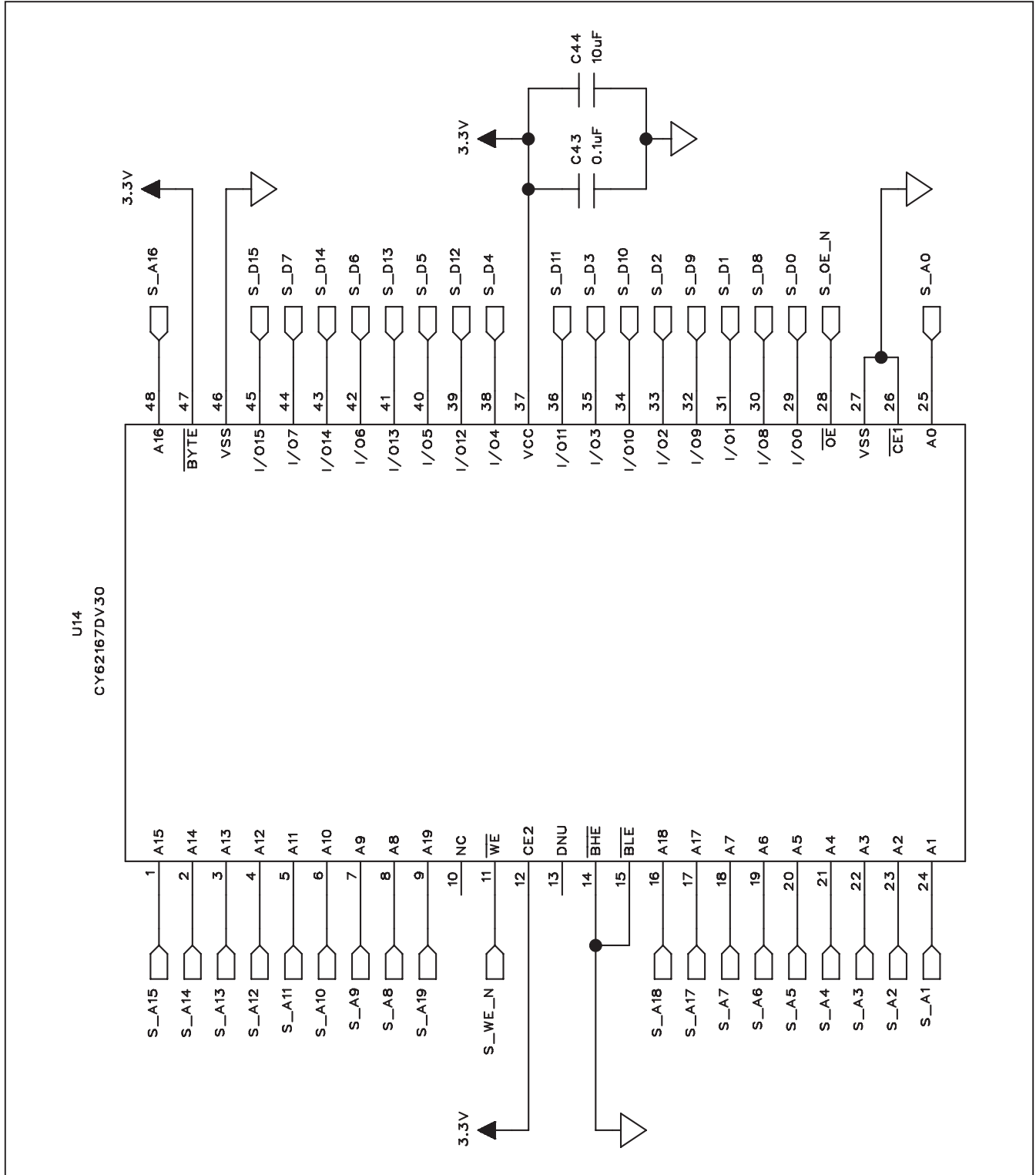

Figure 6I. MAX11105 EV Kit Schematic (Sheet 12 of 12)

MAX11105 Evaluation Kit

Evaluates: MAX11105

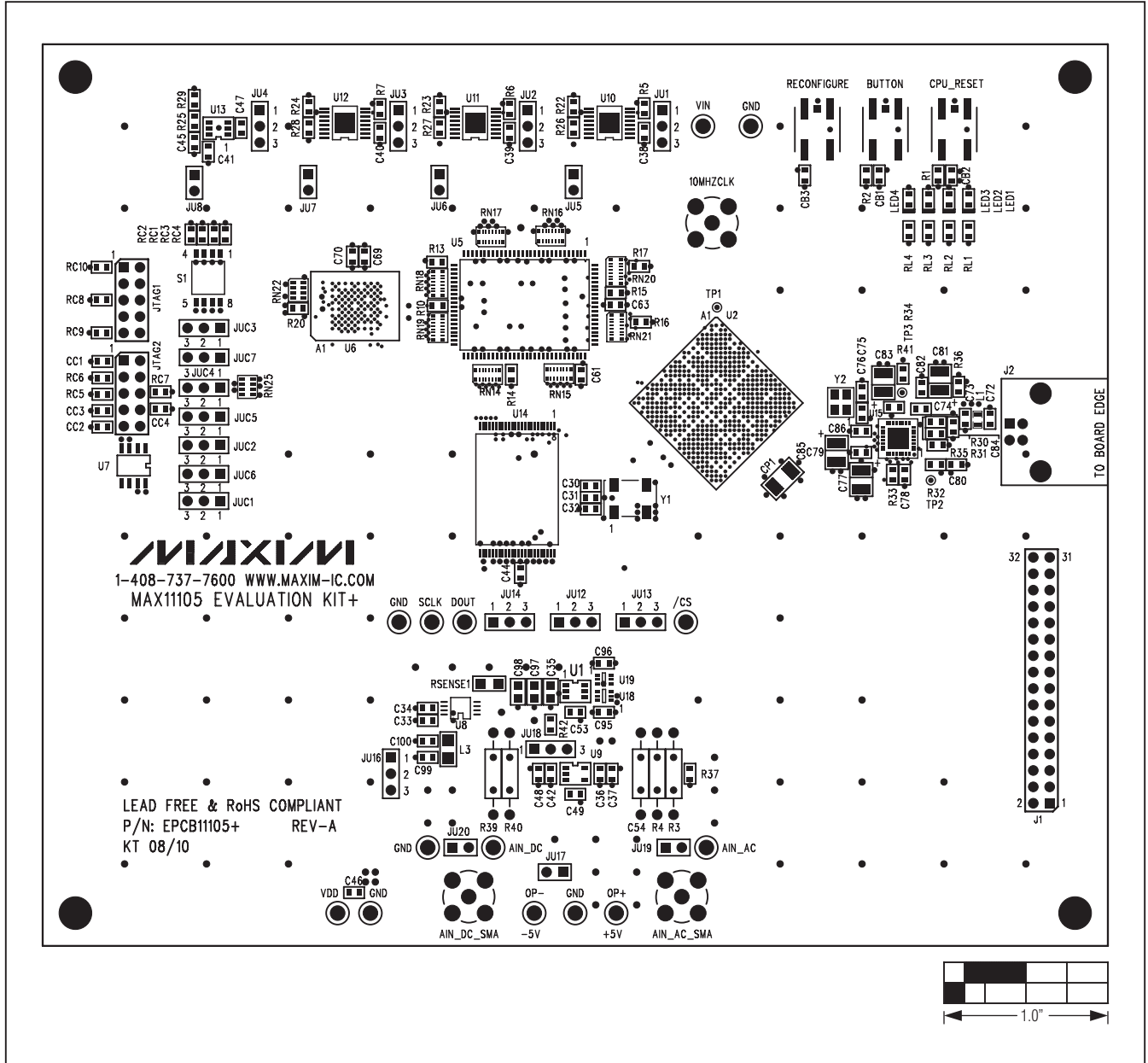

Figure 7. MAX11105 EV Kit Component Placement Guide—Top

MAX11105 Evaluation Kit

Evaluates: MAX11105

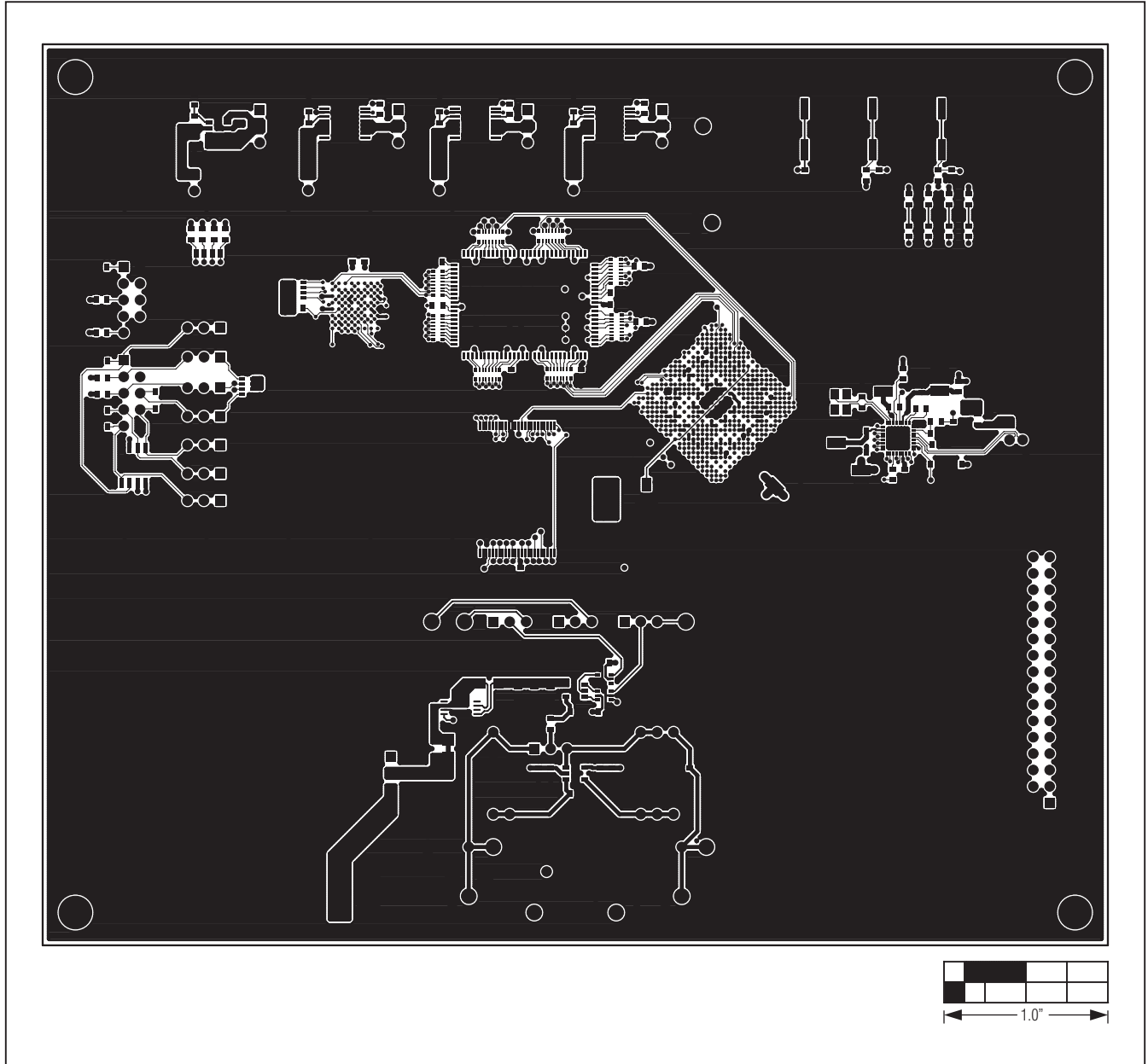

Figure 8. MAX11105 EV Kit PCB Layout—Component Side

MAX1105 Evaluation Kit

Evaluates: MAX1105

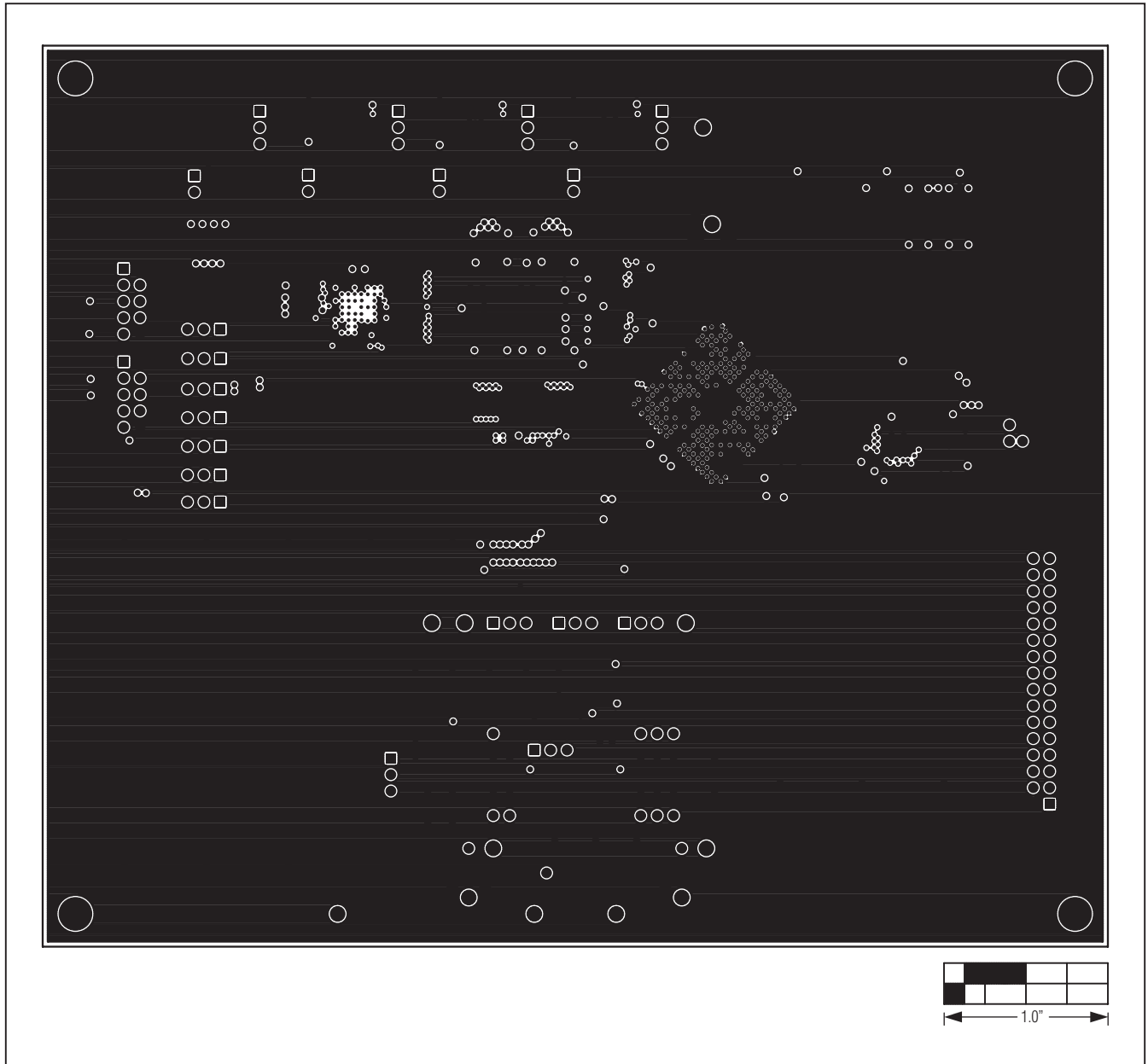

Figure 9. MAX1105 EV Kit PCB Layout—Layer 2

MAX11105 Evaluation Kit

Evaluates: MAX11105

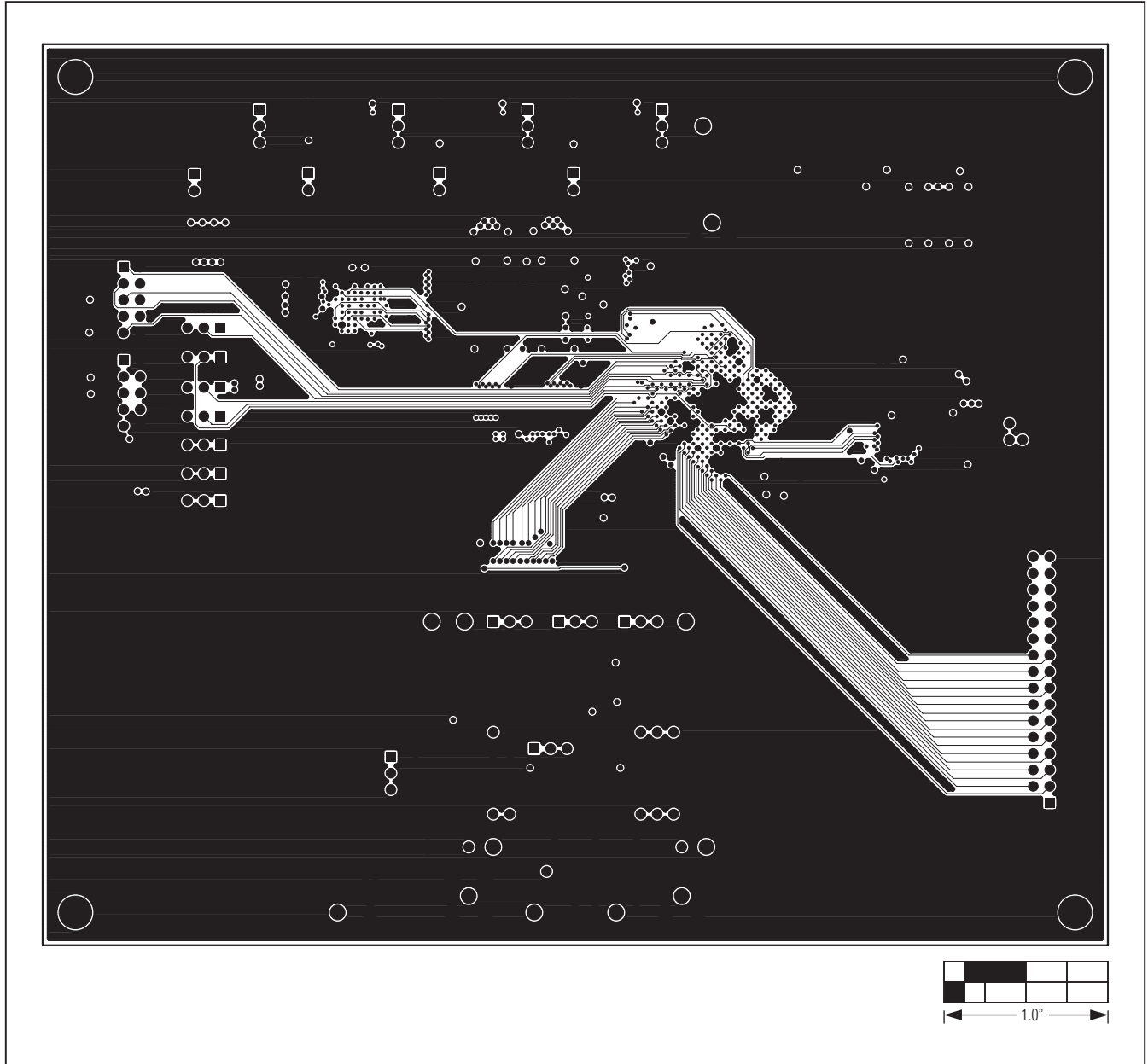

Figure 10. MAX11105 EV Kit PCB Layout—Layer 3

MAX11105 Evaluation Kit

Evaluates: MAX11105

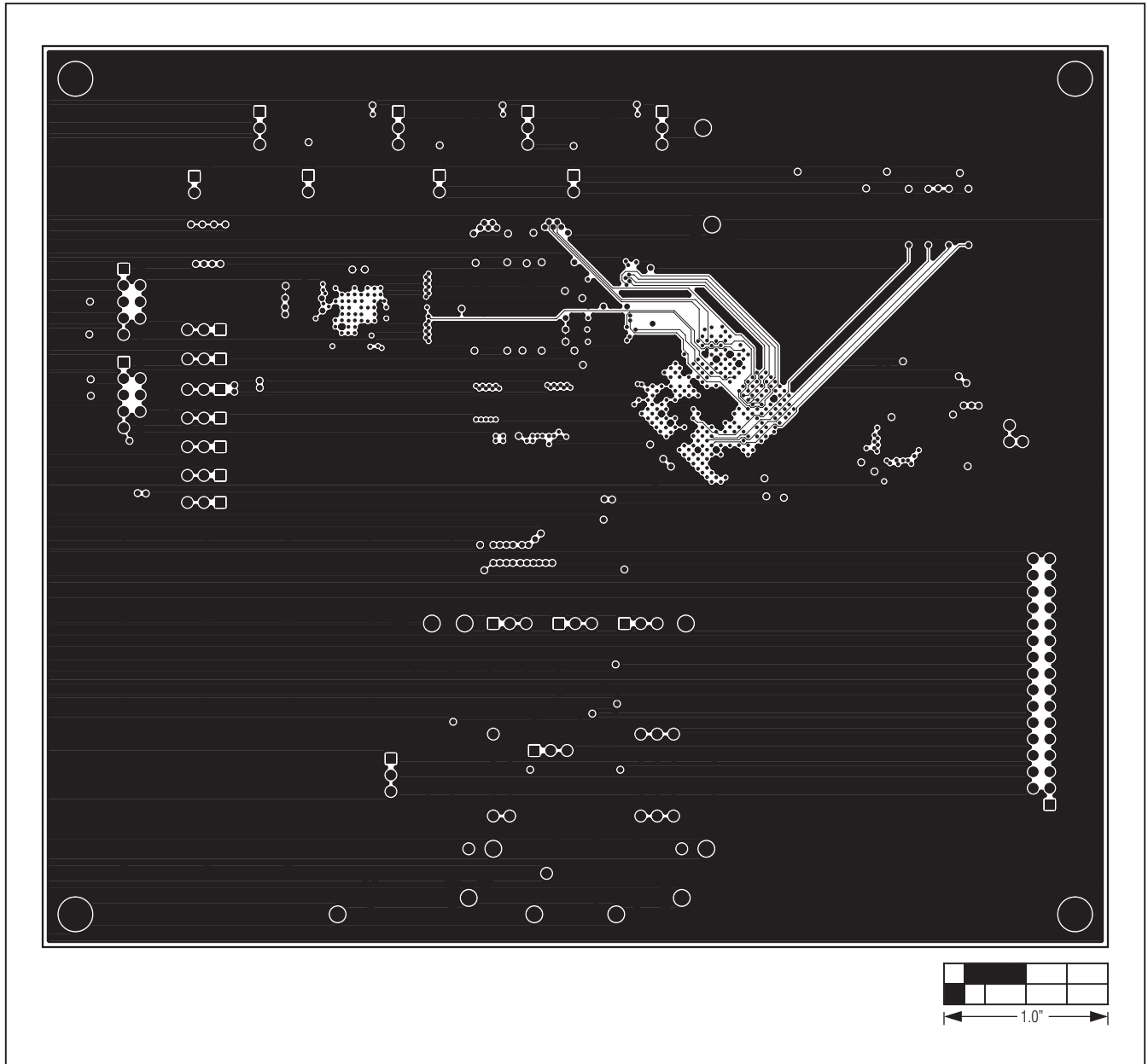

Figure 11. MAX11105 EV Kit PCB Layout—Layer 4

MAX11105 Evaluation Kit

Evaluates: MAX11105

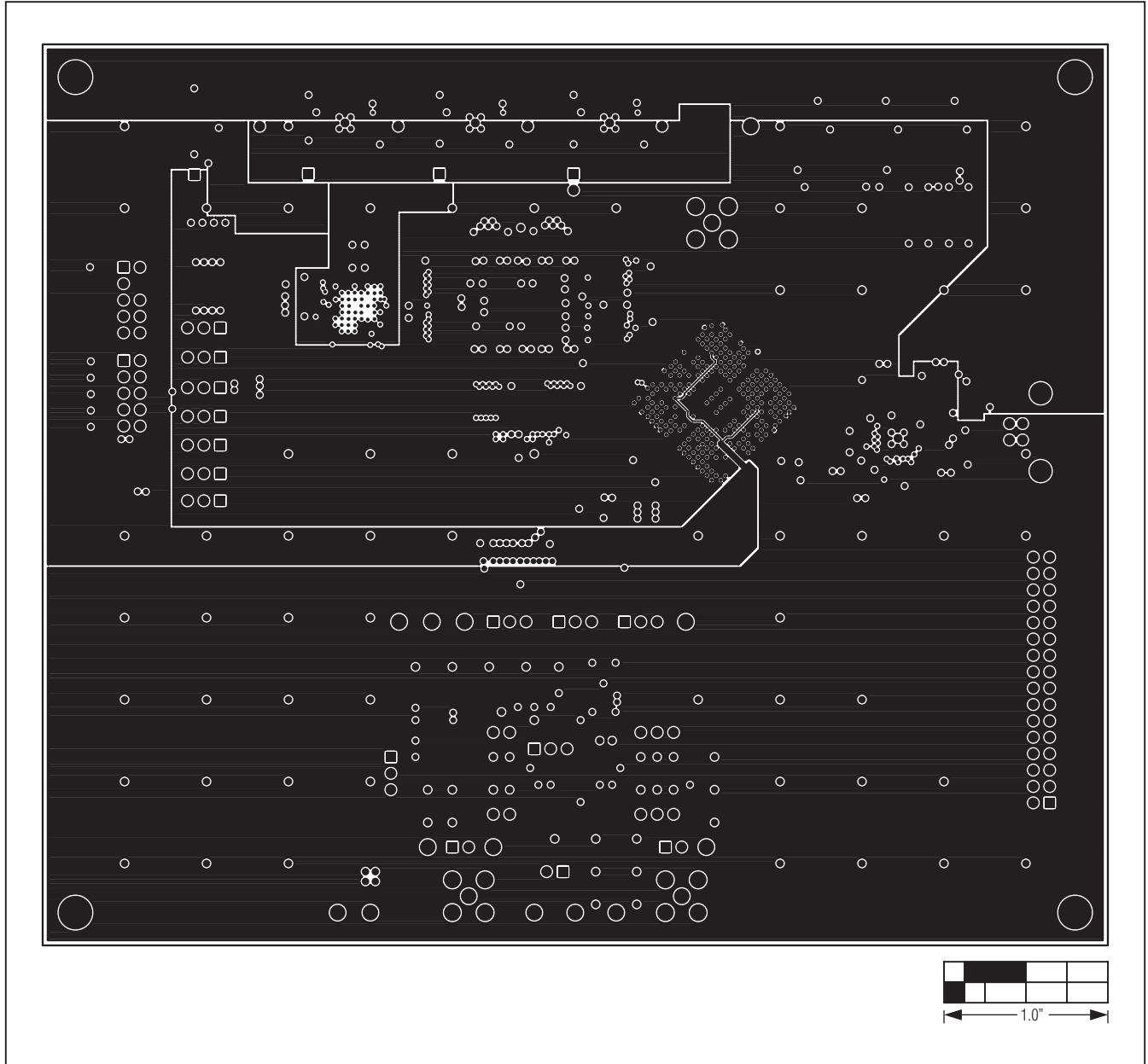

Figure 12. MAX11105 EV Kit PCB Layout—Layer 5

MAX11105 Evaluation Kit

Evaluates: MAX11105

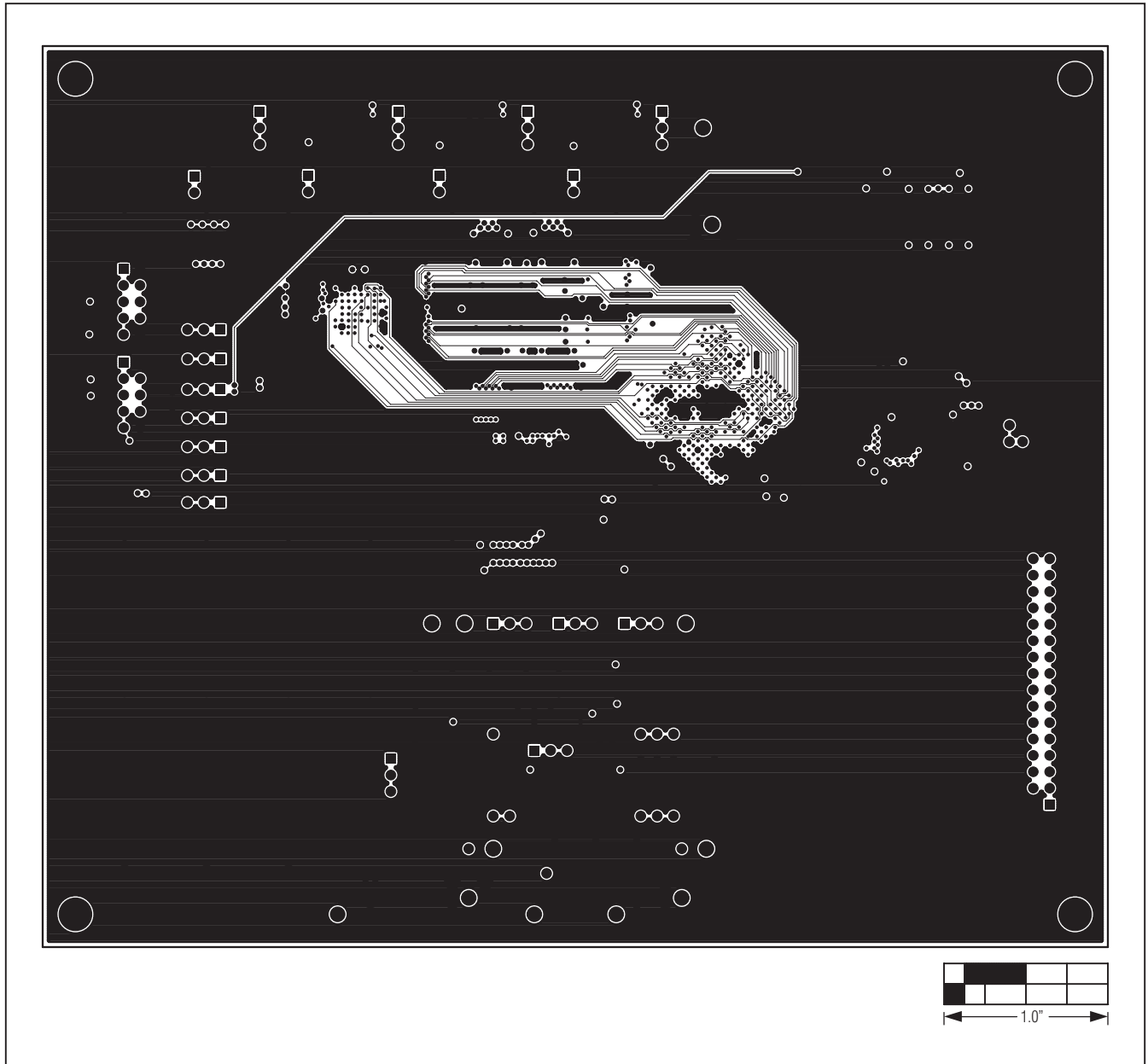

Figure 13. MAX11105 EV Kit PCB Layout—Layer 6

MAX11105 Evaluation Kit

Evaluates: MAX11105

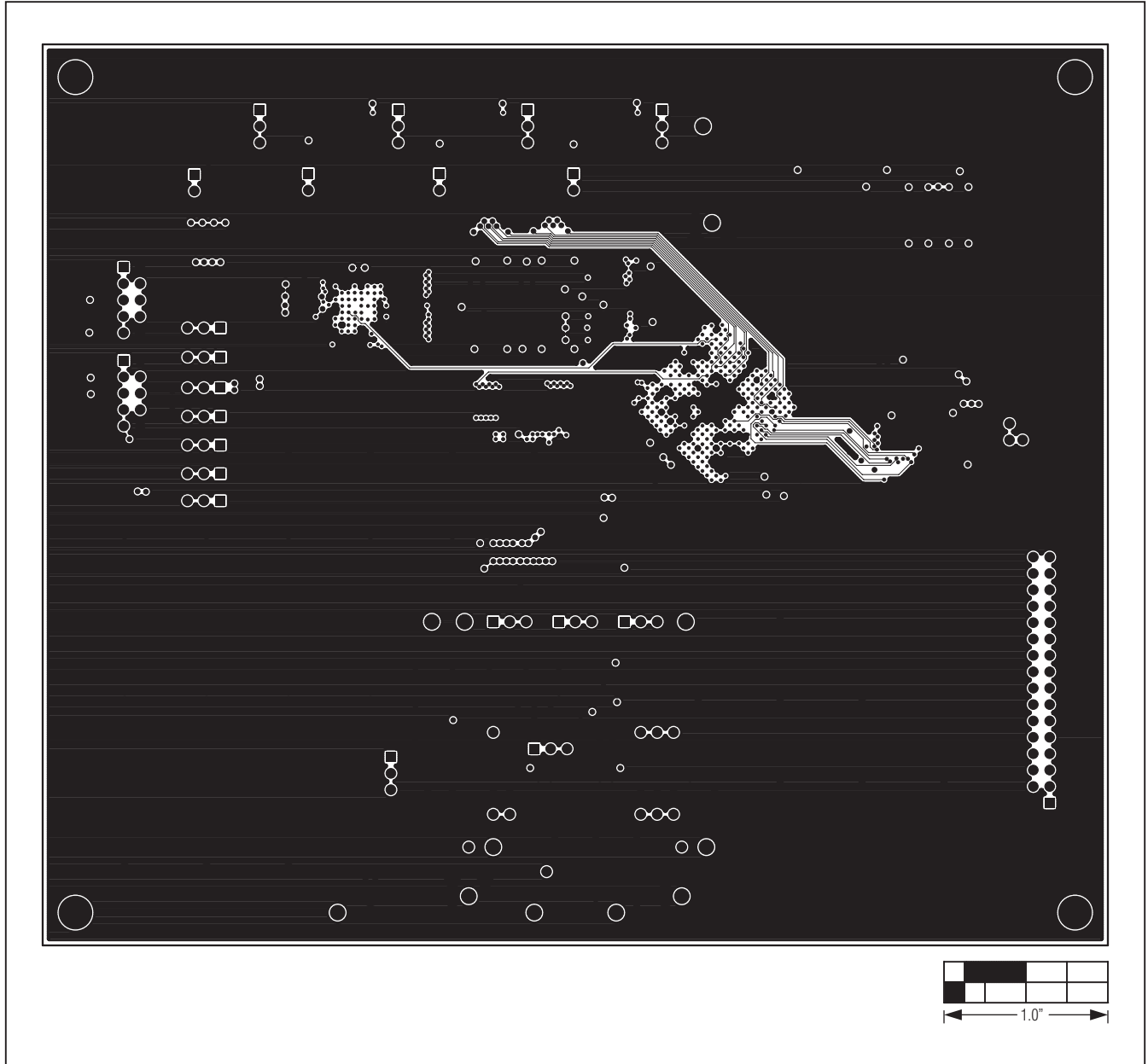

Figure 14. MAX11105 EV Kit PCB Layout—Layer 7

MAX1105 Evaluation Kit

Evaluates: MAX1105

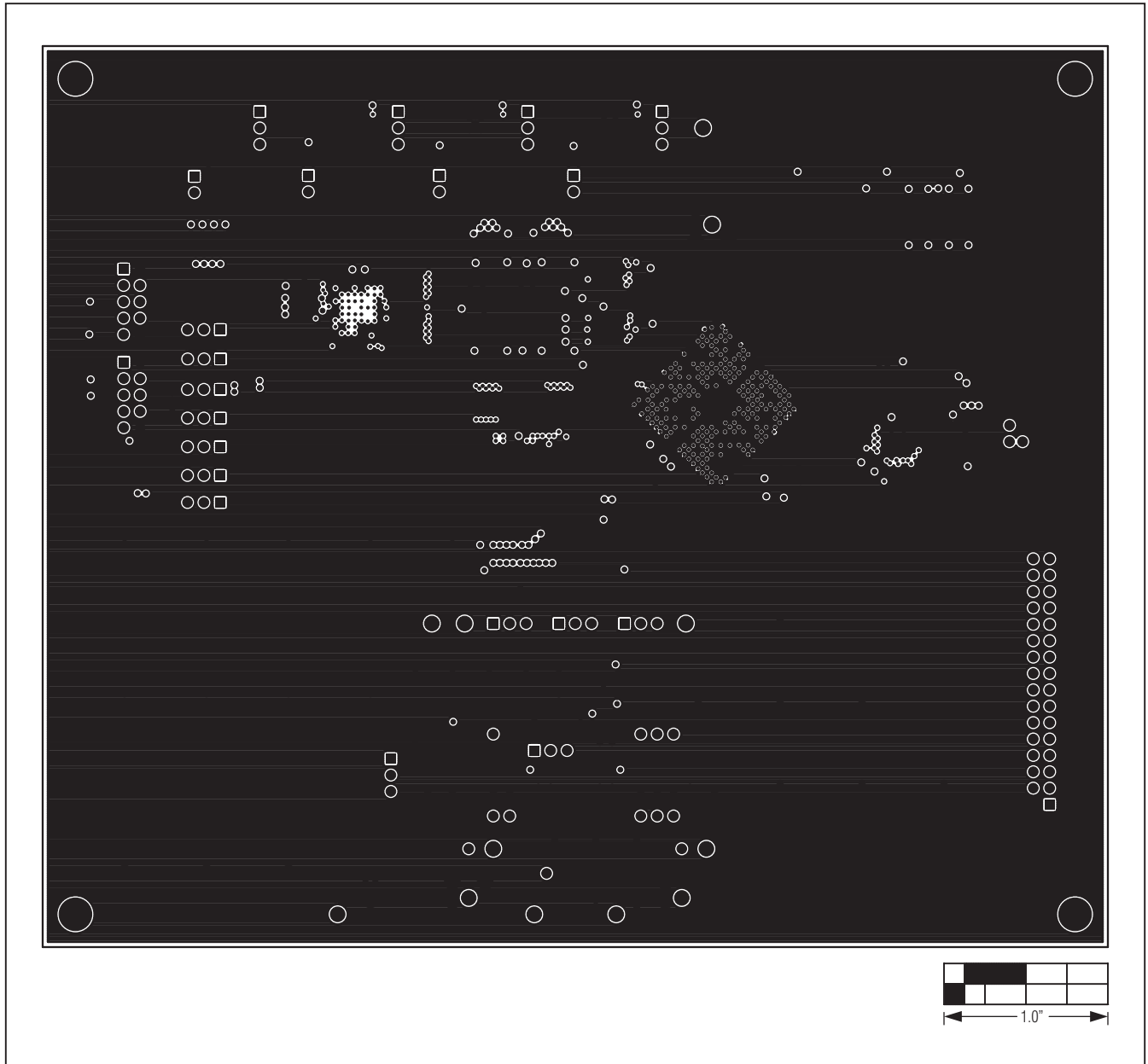

Figure 15. MAX1105 EV Kit PCB Layout—Layer 8

MAX11105 Evaluation Kit

Evaluates: MAX11105

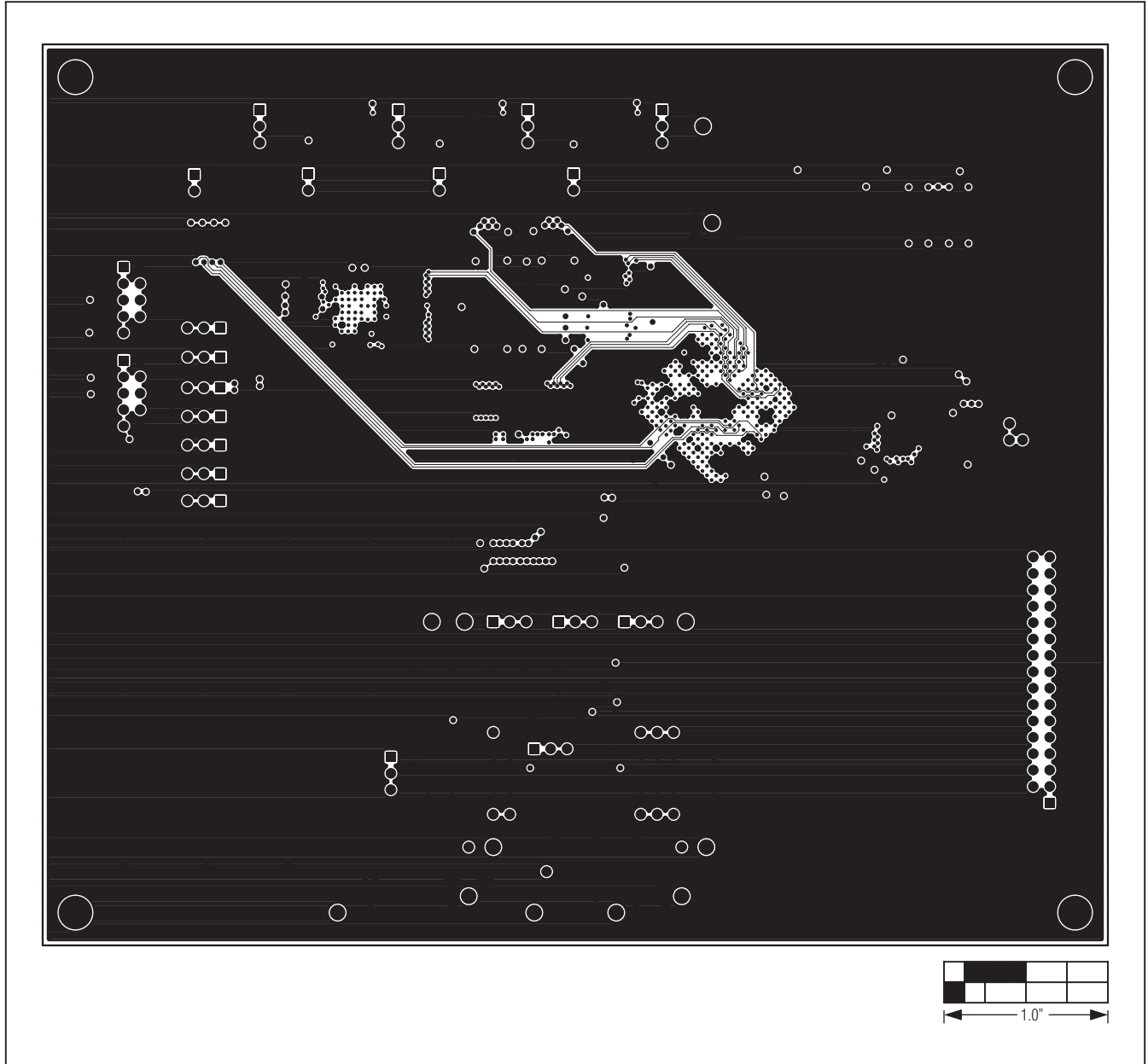

Figure 16. MAX11105 EV Kit PCB Layout—Layer 9

MAX1105 Evaluation Kit

Evaluates: MAX1105

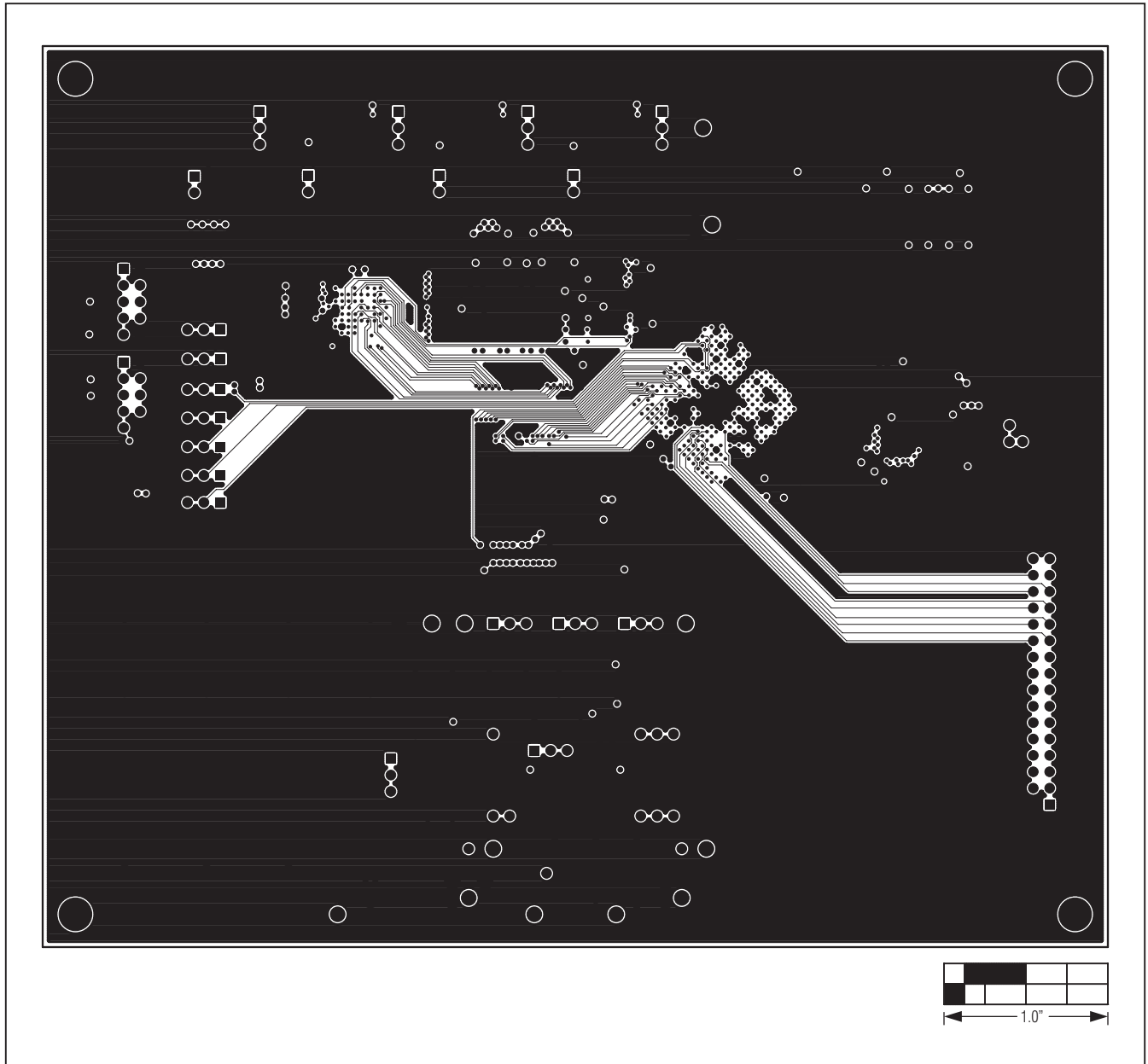

Figure 17. MAX1105 EV Kit PCB Layout—Layer 10

MAX11105 Evaluation Kit

Evaluates: MAX11105

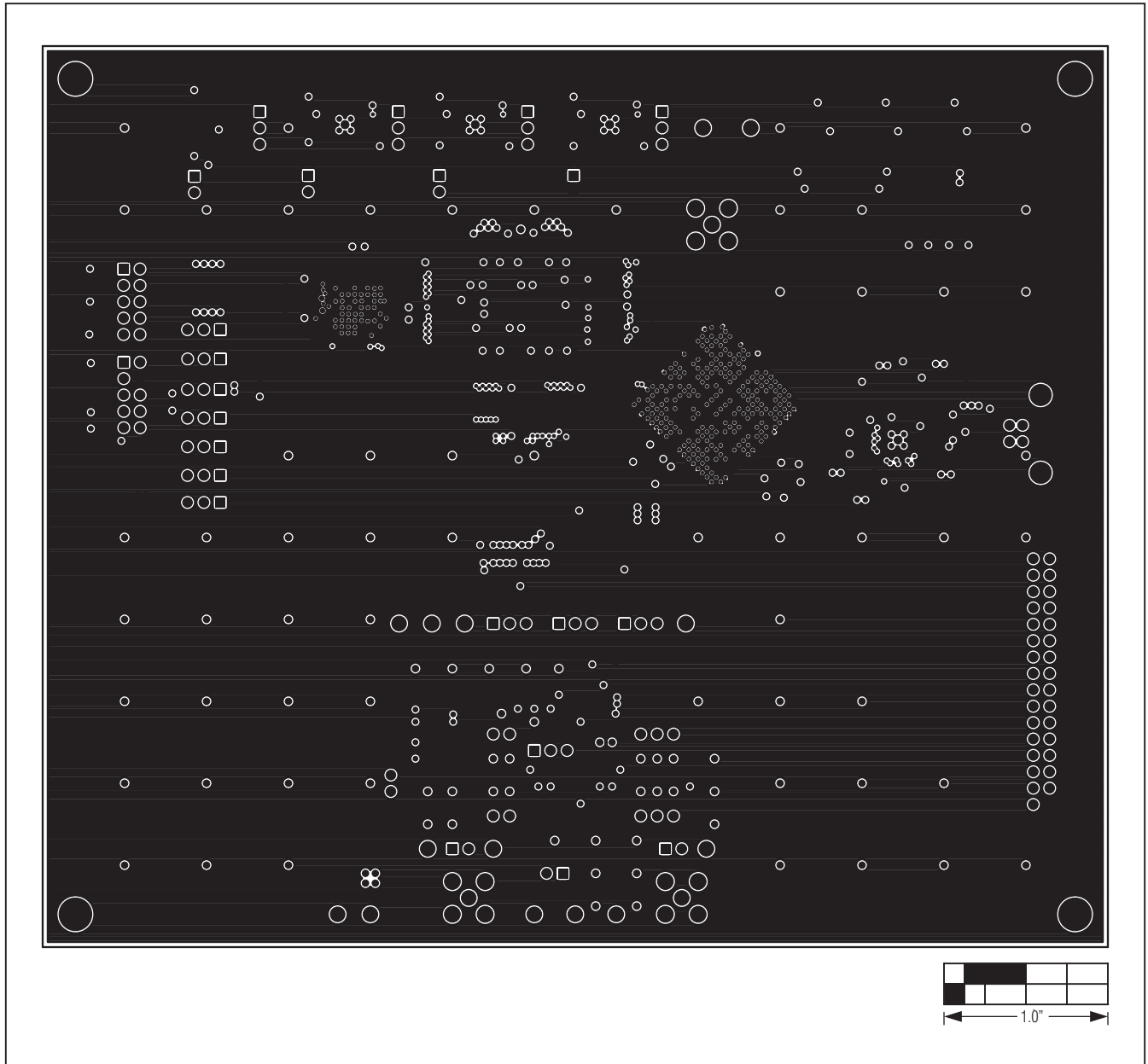

Figure 18. MAX11105 EV Kit PCB Layout—Layer 11

MAX11105 Evaluation Kit

Evaluates: MAX11105

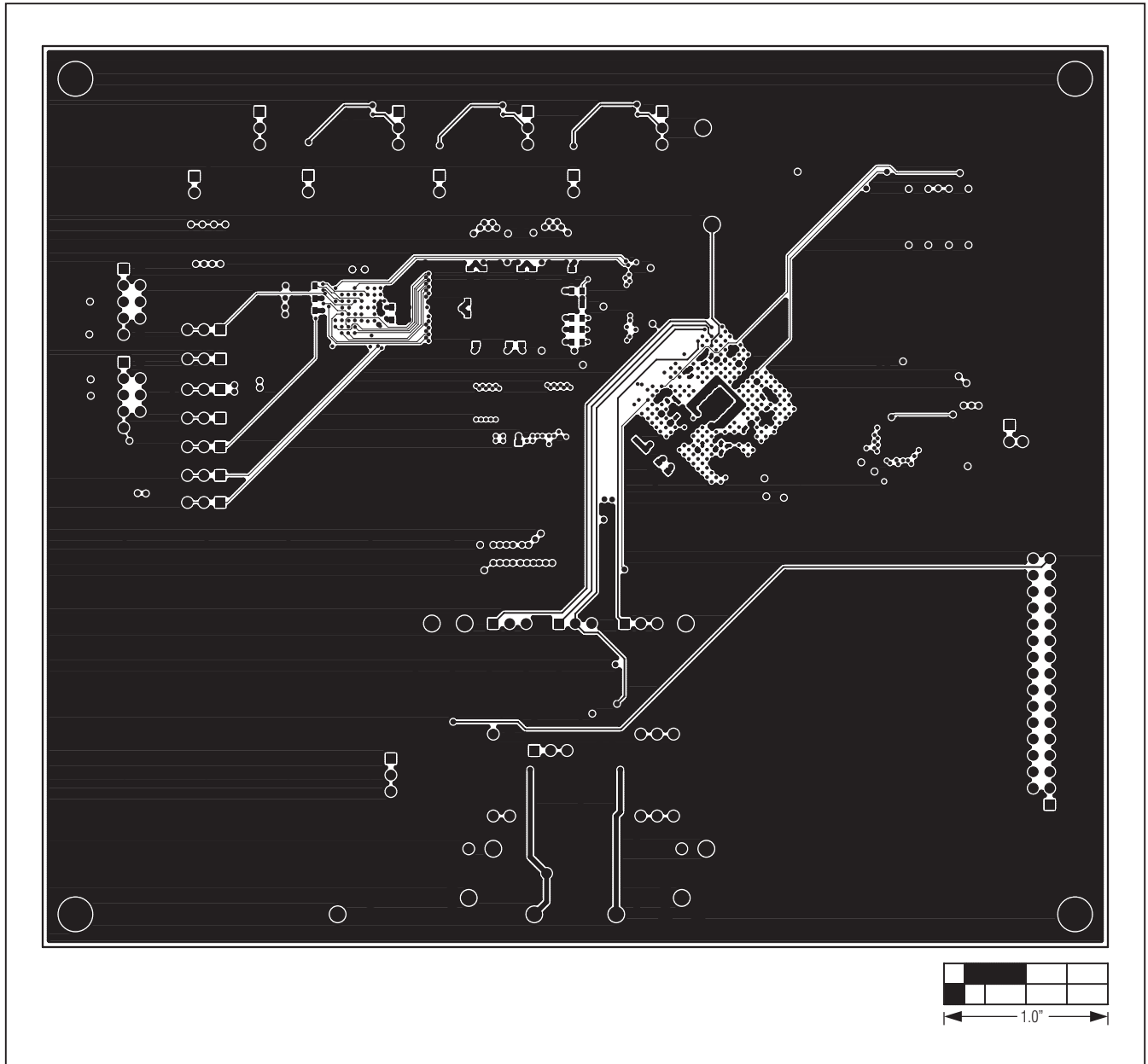

Figure 19. MAX11105 EV Kit PCB Layout—Bottom Side

MAX11105 Evaluation Kit

Evaluates: MAX11105

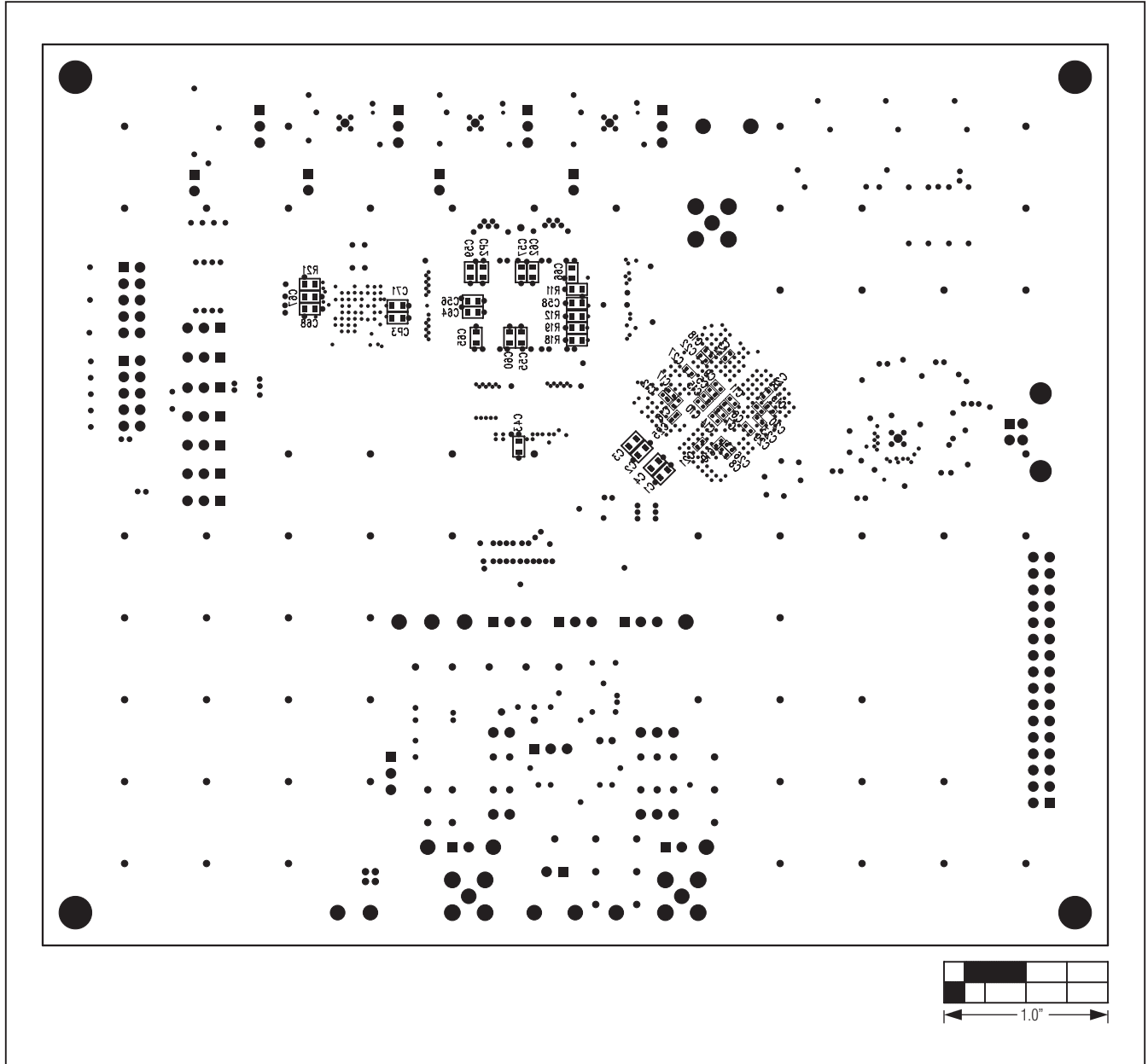

Figure 20. MAX11105 EV Kit Component Placement Guide—Bottom

MAX11105 Evaluation Kit

Revision History

REVISION NUMBER	REVISION DATE	DESCRIPTION	PAGES CHANGED
0	12/10	Initial release	—

Evaluates: MAX11105

Maxim cannot assume responsibility for use of any circuitry other than circuitry entirely embodied in a Maxim product. No circuit patent licenses are implied. Maxim reserves the right to change the circuitry and specifications without notice at any time.

Maxim Integrated Products, 120 San Gabriel Drive, Sunnyvale, CA 94086 408-737-7600 _____ 39