

LAYOUT INSPECTION

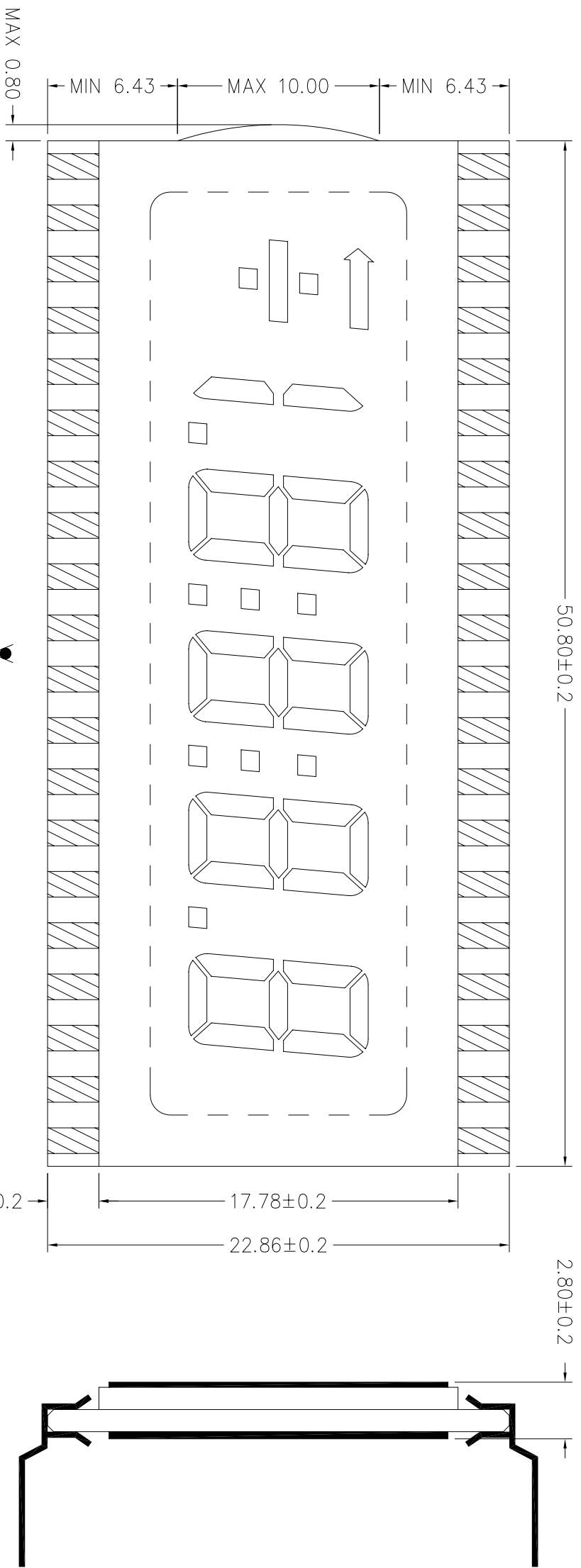

REMARKS: "◇" SPECIAL CHARACTERISTIC
 "+" SAFETY CHARACTERISTIC
 "()" REFERENCE ONLY

DWG NO. : VI-514-1 REV : 0		VARRITRONIX LTD.	
Dimension : mm	TOL : ±0.2 IF NOT SPECIFY	DD NOT SCALE DRAWING	
Drawn by : ZHP	SIGN :	Date : 2004-12-04	
Checked by : YIN	SIGN :	Date :	
3rd ANGLE PROJECTION			

DWG.NO: VI-514-1 (REV.0)

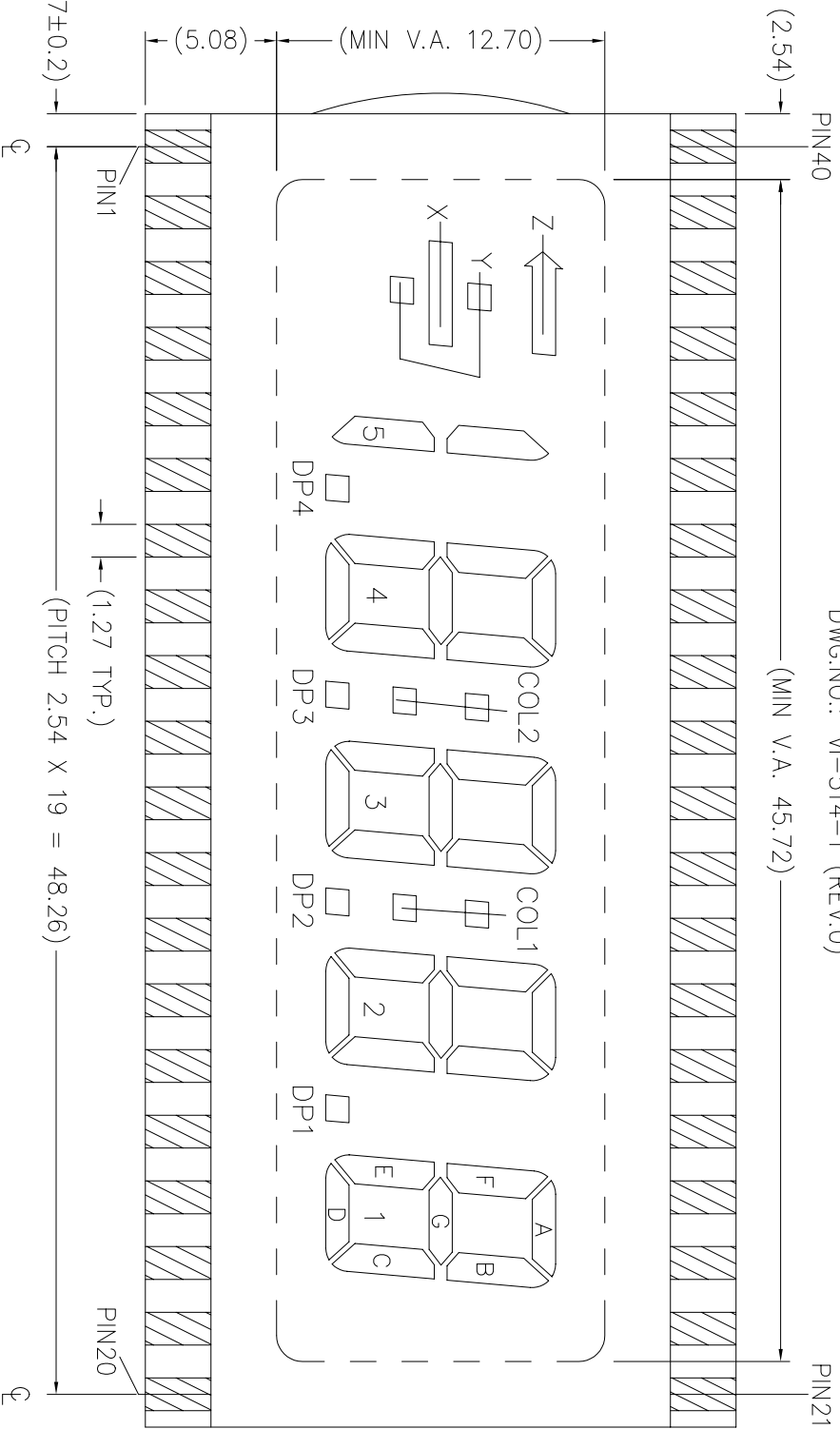

(BEVEL EDGE(4X))

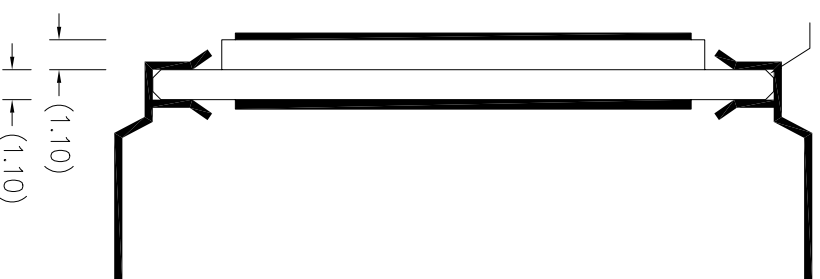

DWG.NO.: VI-514-1 (REV.0)

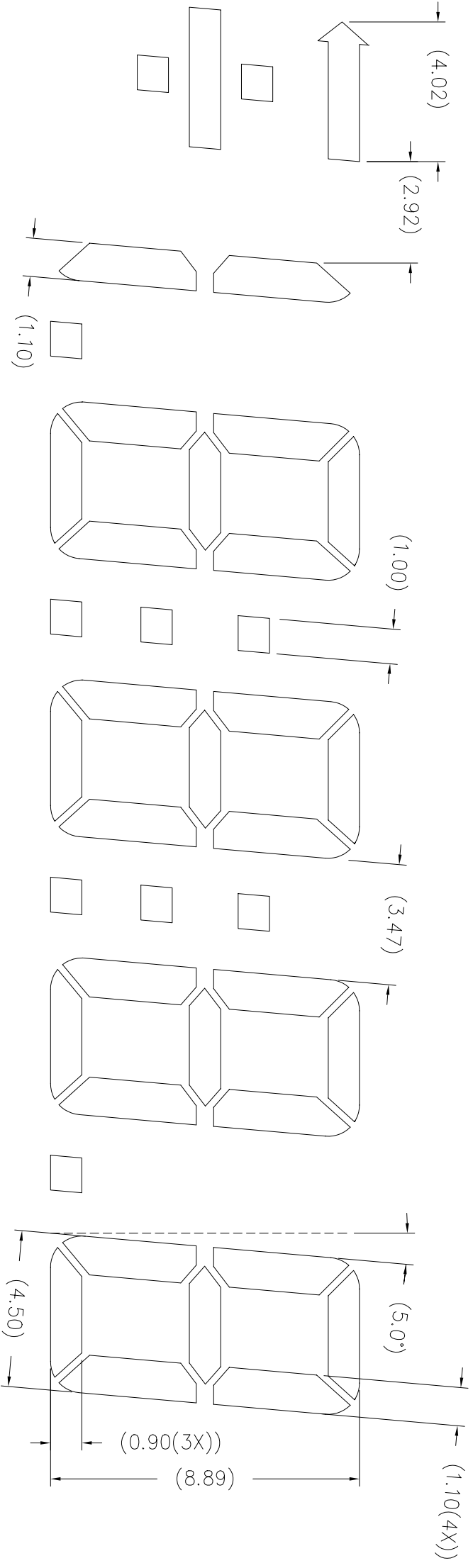

DWG. NO.: VI-514-1 (REV.0)

SEGMENT TRACKING

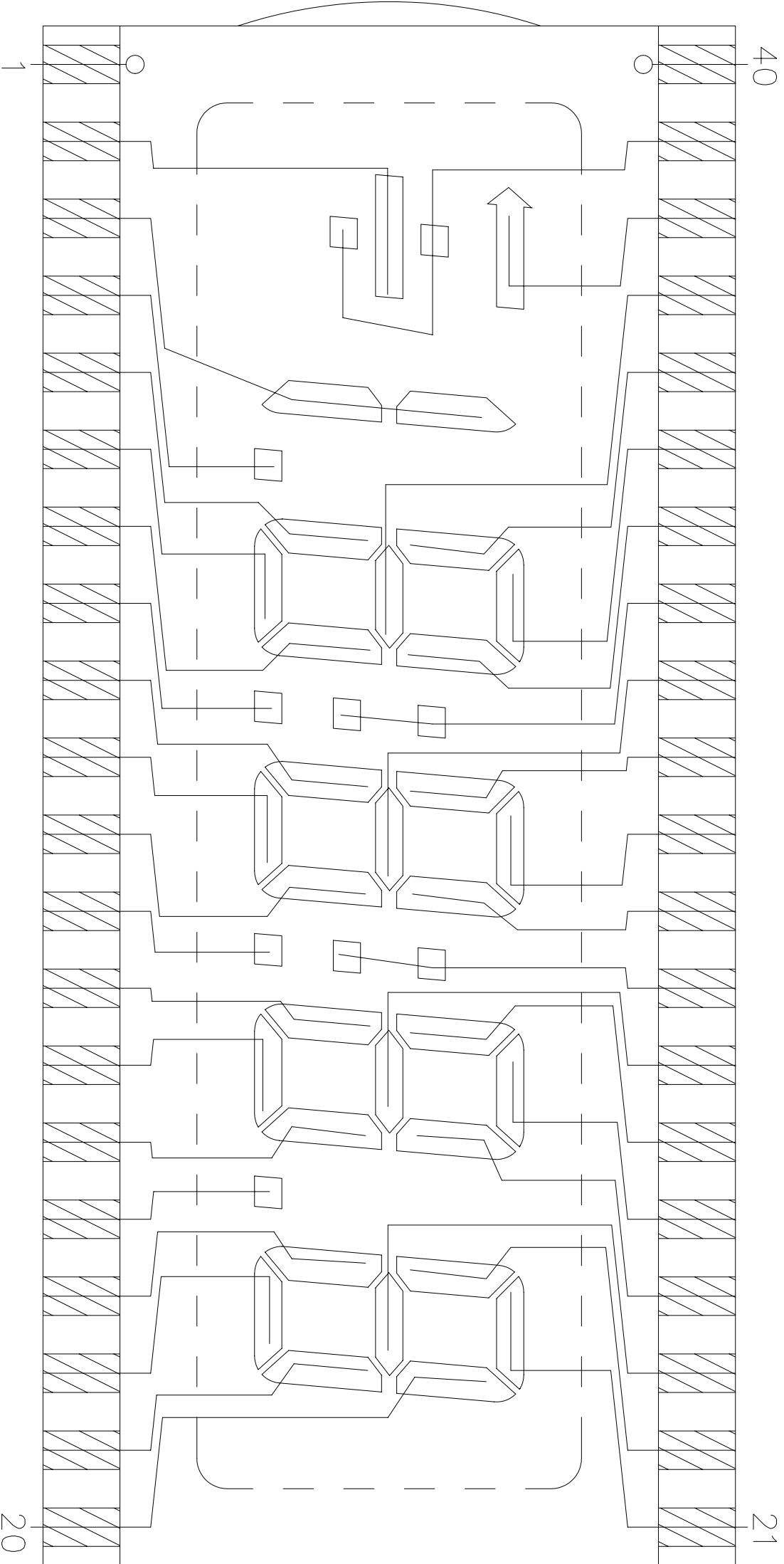

COMMON TRACKING

COM

40

21

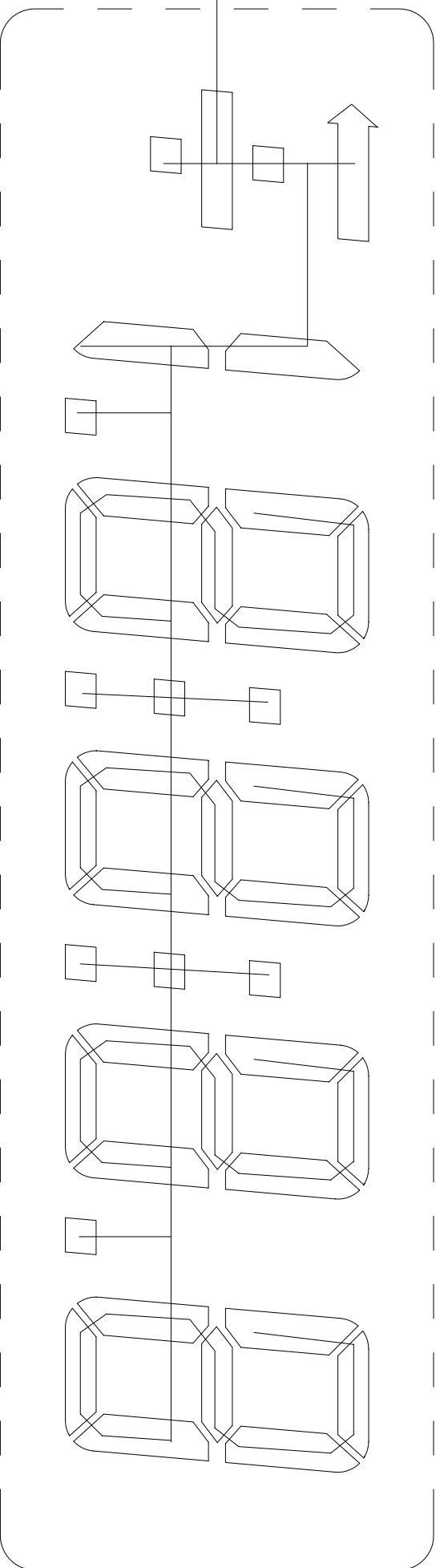

20

COM

20

REMARKS: SAME COMMON SHOULD BE CONNECTED TOGETHER ON THE P.C.B.

VARITRONIX LIMITED		OPEN LAYER :	SCALE
POLARIZER LOCATION DIAGRAM		P	Do not scale
DOC. NO. : PL-VI-514-1-01		Drawn by : ZHP	Date : 2004-12-04
		Checked by : INA	Date : 2004-12-04
		Approval by :	Date : 2004-12-04

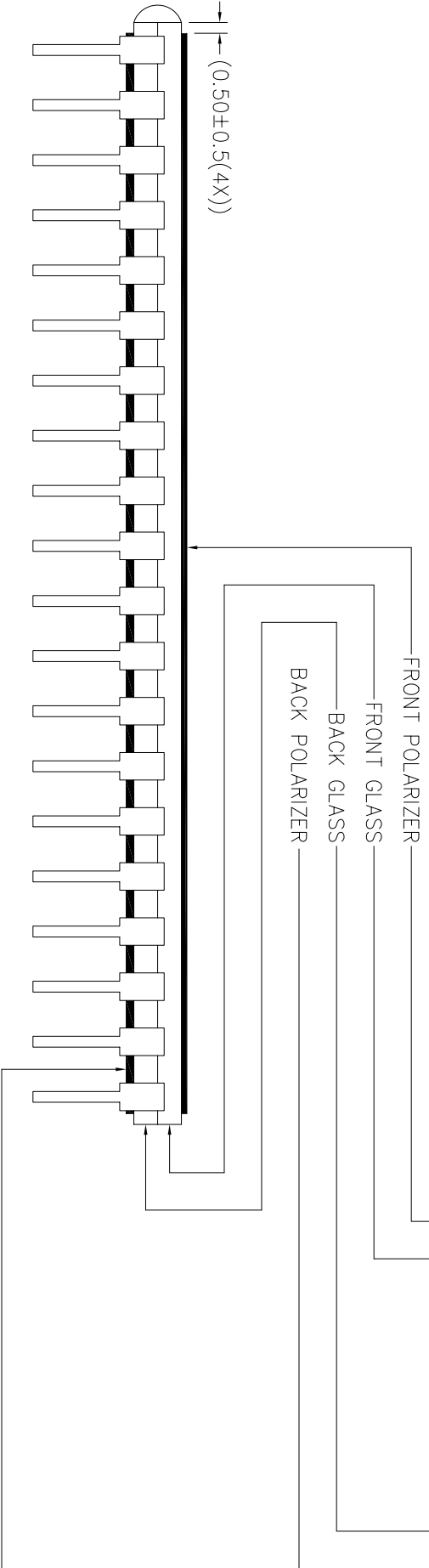
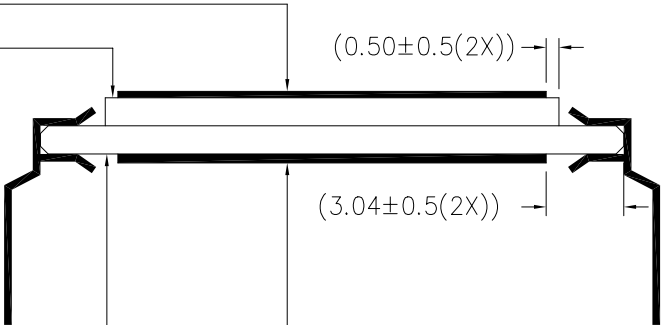
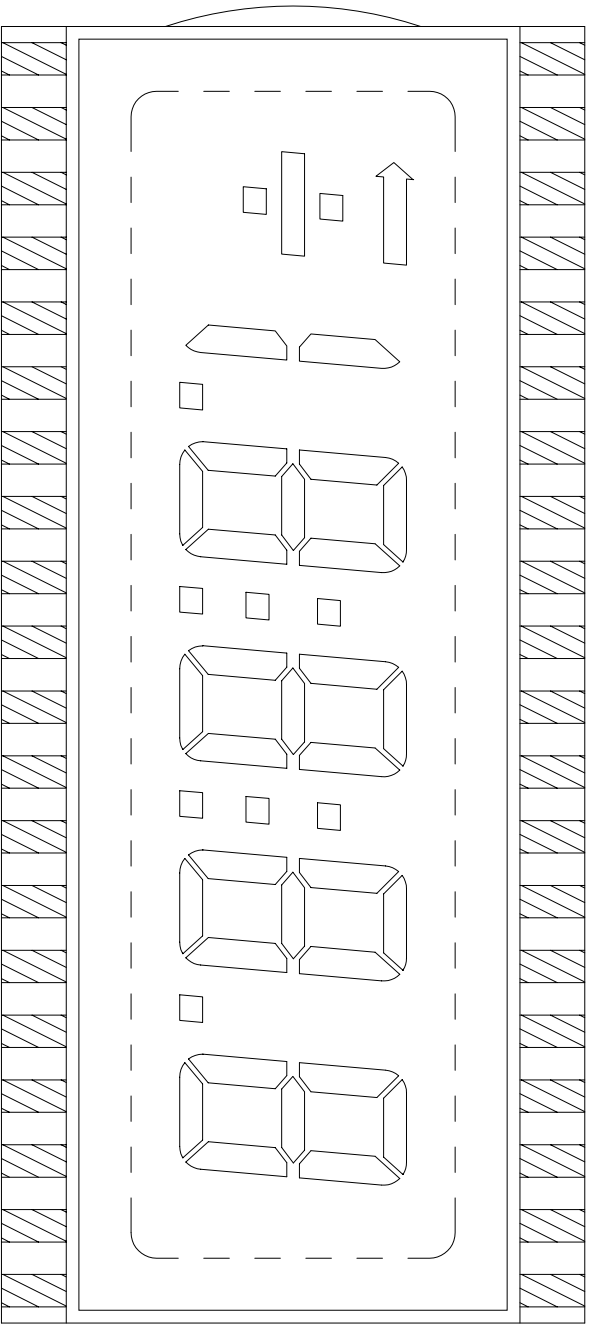

VARITRONIX LIMITED		OPEN LAYER :	SCALE
DIL-PIN DETAILS LOCATION DIAGRAM		DP-L0	Do not scale
DOC. NO. : DP-VI-514-1-01	Drawn by : ZHP	Checked by : INA	Date : 2004-12-04
	Approval by :	Date : 2004-12-04	
ALL DIMENSIONS IN mm			

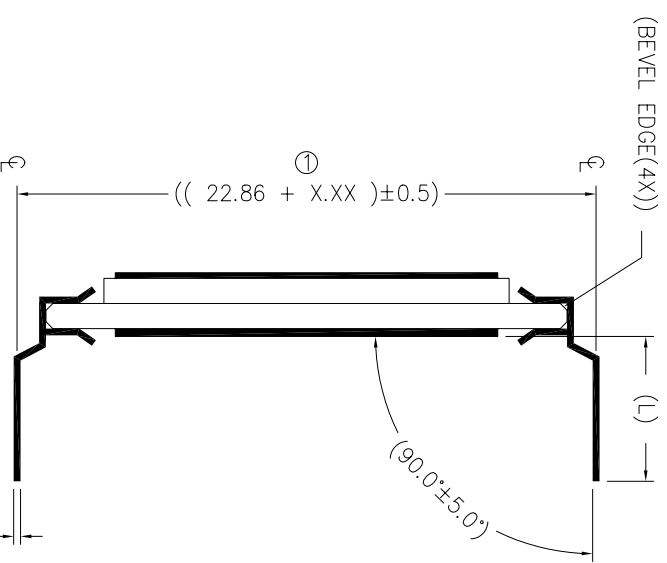
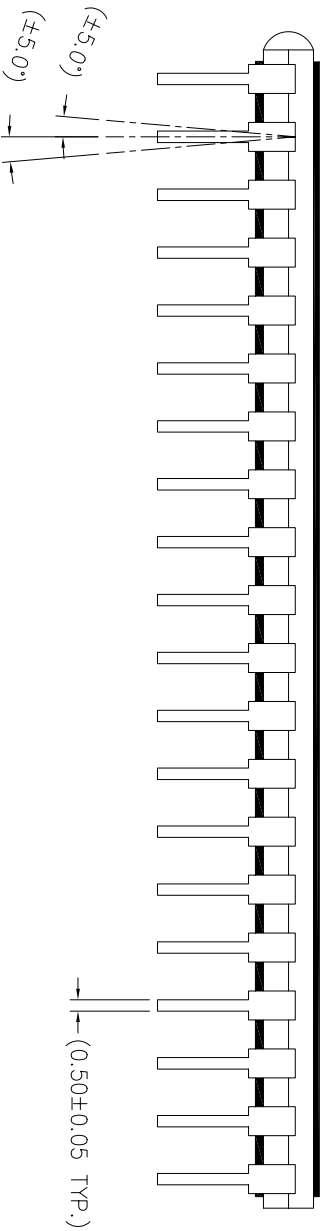
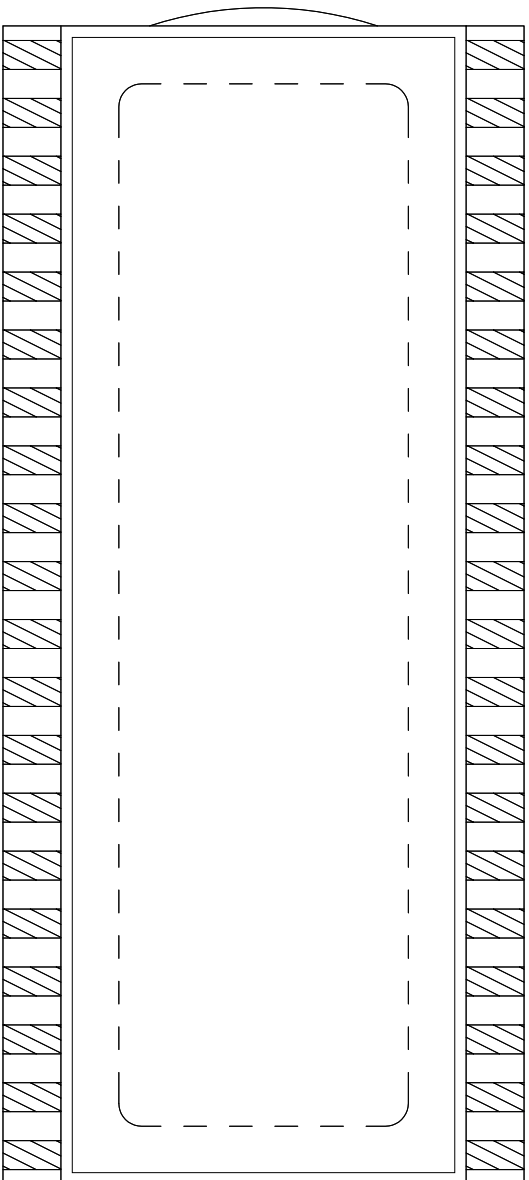

REMARKS: PIN LENGTH (L) REFER TO COVER PAGE

- ① ----- X.XX=2.54 (FOR PIN LENGTH ≥ 3.20 & ≤ 10.00 mm)
- X.XX=1.75 (FOR PIN LENGTH > 10.00 & ≤ 19.50 mm)

DWG.NO.: VI-514-1 (REV.0)

PIN	COM	PIN	COM	PIN	COM	PIN	COM
1	COM	11	3C	21	1A	31	3F
2	X	12	DP2	22	1F	32	3G
3	5B,C	13	2E	23	1G	33	COL2
4	DP4	14	2D	24	2B	34	4B
5	4E	15	2C	25	2A	35	4A
6	4D	16	DP1	26	2F	36	4F
7	4C	17	1E	27	2G	37	4G
8	DP3	18	1D	28	COL1	38	Z
9	3E	19	1C	29	3B	39	Y
10	3D	20	1B	30	3A	40	COM

REMARKS : SAME COMMON SHOULD BE CONNECTED TOGETHER ON P.C.B.