

THIS DOCUMENT IS THE PROPERTY OF
KEYSTONE ELECTRONICS CORP. AND
SHALL NOT BE REPRODUCED, DISTRIBUTED
OR USED AS A BASIS FOR MANUFACTURE
WITHOUT PRIOR WRITTEN PERMISSION
FROM KEYSTONE ELECTRONICS CORP.

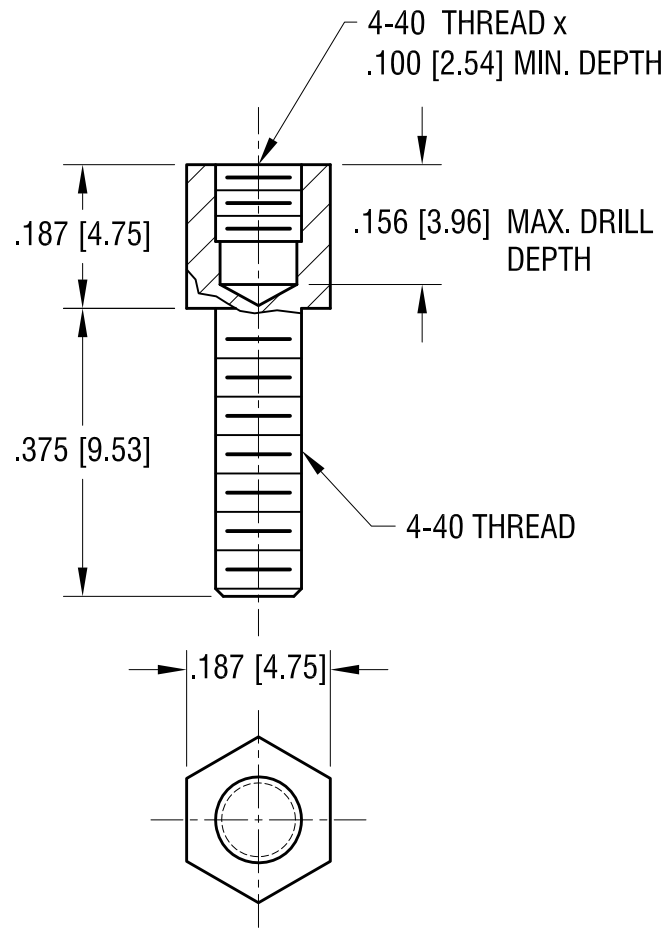

NOTE:

- 1. FINISH: ZINC PLATE, TRIVALENT
YELLOW CHROMATE

KEYSTONE ELECTRONICS CORP.			
www.keyelco.com • ASTORIA, N.Y. 11105-2017 • Tel (718) 956-8900			
PART NAME		JACK SCREW	
MATERIAL		STEEL	
FINISH		DRN BY	DATE
AS NOTED		BOONE	2.1.06
		APP'D	SCALE
		LN	4X
TOLERANCES	INCH [MM]	CODE	DWG NO.
DECIMAL	± .005 [± 0.15]	C/M	7241
ANGULAR	± 1°		
UNLESS OTHERWISE SPECIFIED			

8.17.09	CHANGE AS PER ECN 09-115	A
DATE	DESCRIPTION	REV.