

SP-Cap

Conductive Polymer Aluminum Electrolytic Capacitors



Notices

■ Applicable Laws and Regulations

- This product complies with the RoHS Directive (Restriction of the use of certain Hazardous substances in electrical and electronic equipment (DIRECTIVE 2011/65/EU).
- No Ozone Depleting Chemicals(ODC's), controlled under the Montreal Protocol Agreement, are used in producing this product.
- We do not PBBs or PBDEs as brominated flame retardants.
- Export procedure which followed export related regulations, such as foreign exchange and a foreign trade method, on the occasion of export of this product Thank you for your consideration.

■ Limited applications

- This capacitor is designed to be used for electronics circuits such as audio/visual equipment, home appliances, computers and other office equipment, optical equipment, measuring equipment.
- High reliability and safety are required [be / a possibility that incorrect operation of this product may do harm to a human life or property] more. When use is considered by the use, the delivery specifications which suited the use separately need to be exchanged.

Items to be observed

- This specification guarantees the quality and performance of the product as individual components. Before use, check and evaluate their compatibility with installed in your products.
- Do not use the products beyond the specifications described in this document.

■ For specifications

- Install the following systems for a failsafe design to ensure safety if these products are to be used in equipment where a defect in these products may cause the loss of human life or other signification damage, such as damage to vehicles (automobile, train, vessel), traffic lights, medical equipment, aerospace equipment, electric heating appliances, combustion/ gas equipment, rotating rotating equipment, and disaster/crime prevention equipment.
 - The system is equipped with a protection circuit and protection device.
 - The system is equipped with a redundant circuit or other system to prevent an unsafe status in the event of a single fault.

■ Conditions of use

- Before using the products, carefully check the effects on their quality and performance, and determined whether or not they can be used. These products are designed and manufactured for general-purpose and standard use in general electronic equipment. These products are not intended for use in the following special conditions.
 - (1) In liquid, such as Water, Oil, Chemicals, or Organic solvent.
 - (2) In direct sunlight, outdoors, or in dust.
 - (3) In vapor, such as dew condensation water of resistive element, or water leakage, salty air, or air with a high concentration corrosive gas, such as Cl₂, H₂S, NH₃, SO₂, or NO_x.
 - (4) In an environment where strong static electricity or electromagnetic waves exist.
 - (5) Mounting or placing heat-generating components or inflammables, such as vinyl-coated wires, near these products.
 - (6) Sealing or coating of these products or a printed circuit board on which these products are mounted, with resin and other material.
 - (7) Using solvent, water or water-soluble cleaner for flux cleaning agent after soldering. (In particular, when using water or a water-soluble cleaning agent, be careful not to leave water residues)
 - (8) Using in the atmosphere which strays Acid or alkaline.
 - (9) Using in the atmosphere which there are excessive vibration and shock.
- Please arrange circuit design for preventing impulse or transitional voltage. Do not apply voltage, which exceeds the full rated voltage when the capacitors receive impulse voltage, instantaneous high voltage, high pulse voltage etc.
- Our products there is a product are using an electrolyte solution. Therefore, misuse can result in rapid deterioration of characteristics and functions of each product. Electrolyte leakage damages printed circuit and affects performance, characteristics, and functions of customer system.

⚠ Application Guidelines (SP-Cap)

1. Circuit design

1.1 Prohibited circuits for use

Do not use the SP-Cap with the following circuit.

- (1) Time-constant circuit
- (2) Coupling circuits
- (3) 2 or more SP-Cap connected serially
- (4) Circuit which are greatly affected by leakage current
- (5) High-impedance voltage retention circuits

1.2 Voltage and polarity

The application of over-voltage and reverse voltage described below can cause increases in leakage current and short circuits.

Applied voltage, refers to the voltage value including the peak value of the transitional Instantaneous voltage and the peak value of ripple voltage, not just steady line voltage.

Design your circuit so that the peak voltage does not exceed the stipulated voltage.

[Over-Voltage]

Do not apply over-voltage in excess of the rated voltage. Do not apply voltage, which exceeds the full rated voltage when the SP-Cap receive impulse voltage, instantaneous high voltage, high pulse voltage etc.

[Reverse-Voltage]

Do not apply reverse-voltage

1.3 Ripple current

Use the SP-Cap within the stipulated permitted ripple current.

When excessive ripple current is applied to the SP-Cap, it causes increases in leakage current and short circuits due to self-heating.

Even when using the SP-Cap under the permissible ripple current, reverse voltage may occur if the DC bias voltage is low.

1.4 Leakage current

There is a risk of leakage current characteristics increasing even if the following use environments are within the stipulated range.

However, even if the leakage current increases, the SP-Cap self-repairing function will reduce the leakage current in most cases when a voltage is applied.

- (1) After re-flow
- (2) Shelf conditions such as high temperature with no load, high temperature high humidity with no load and sudden temperature changes.

1.5 Temperature

Use at or under the rated (guaranteed) temperature.

Operation at temperatures exceeding specifications causes large changes in the SP-Cap electrical properties, and deterioration than can potentially lead to failure.

When calculating the operating temperature of the SP-Cap, be sure to include not only the ambient temperature and internal temperature of the unit, but also radiation from heat generating elements inside the unit (power transistors, resistors, etc.), and self-heating due to ripple current.

1.6 Calculation of the expected life time

Expected life is affected by operating temperature.

Generally, the capacitance change ratio will be 1/10 by each 20 °C reduction in temperature, so estimated life time will be expected 10 times.

As below can be calculated the formula for expected life time L_x (h) of SP-Cap at T_x (°C) based on the capacitance change ratio by temperature reduction.

Not guaranteed is the life time which is obtained by this formula as well as upper limit of valid expected life time is 20 years.

$$L_x = L_0 \times 10^{\left(\frac{T_0 - T_x}{20}\right)}$$

T_0 (°C) : Upper category temperature

T_x (°C) : Temperature in actual use (Temperature of SP-Cap)

L_0 (h) : Guaranteed life at (T_0)

L_x (h) : Life expectancy in actual use (T_x)

1.7 Failure rate

The majority of failure modes are short circuits or increases in leakage current.

The main factors of failure are mechanical stress, heat stress and electric stress due to re-flow and heat from the use temperature environment.

Even within the stipulated limits, it is possible to lower the failure rate by reducing use conditions such as temperature and voltage. Please be sure to have ample margin in your design.

[Expected Failure Rate]

- (1) Date based on our reliability tests: 8.2 Fit or less (Based on applied rated voltage at 105 °C)
- (2) Market failure rate: 0.13 Fit or less (Based on $c=0$, Reliability standard : 60 %)

1.8 Mounting area consideration

Isolate the surface of PCB under the mounted SP-Cap.

2. Mounting

2.1 When mounting

- (1) Check the SP-Cap ratings (capacitance and voltage) before mounting.
- (2) Check the SP-Cap polarity before mounting.
- (3) Check the land size for the SP-Cap before mounting.
- (4) When using a mounter, if the pressure for mounting is too high, then the current leak may increase, short-circuiting may occur, or the SP-Cap may break down or come off.

2.2 Soldering

- (1) Reflow soldering
Be performed by one of following methods.
 - (a) Ambient heat conduction reflow (IR / Hot-air)
Please refer to the page of "Mounting Specifications".
 - (b) Vapor phase reflow (but only allowable for CX, CT, SX, ST, GX, LX, LT and HX series).
Please contact Panasonic for details of allowable vapor phase reflow condition.
- (2) Wave soldering and dip soldering
Please remind SP-Cap is NOT compatible.
- (3) Hand soldering
Excessive force stress to the SP-Cap should be avoided
Conditions :
Tip temperature of soldering iron : 350 °C max.
Exposure time : 10 s max.
* Once removed from the printed circuit board for any reason, please do not use the SP-Cap again.

2.3 Land size

Refer to the land size of "Mounting specifications" for appropriate design dimensions.
Circuit board design requires examination of the most suitable dimensions taking conditions such as circuit board, parts and reflow into consideration.

2.4 Mechanical stress

Do not apply excessive force to the SP-Cap this can damage the electrodes and badly affect the SP-Cap mount ability. It can also cause the increase of leakage current, separation of the lead wire and element, and damage to the SP-Cap body, all of which can badly affect the electrical performance of the SP-Cap.

2.5 Circuit board cleaning

SP-Cap should be cleaned after soldering in accordance with the following conditions.

Temperature : Less than 60 °C

Time : Within 5min

Be sure to sufficiently wash and dry (20 min at 100 °C) the board afterward.

[Recommended Cleaning Solvents]

Pine Alpha ST-100S, Clean-thru 750H / 750L / 710M, Aqua Cleaner 210SEP, Sunelec B-12

DK Beclear CW-5790, Techno Cleaner 219, Cold Cleaner P3-375, Telpene Cleaner EC-7R

Technocare FRW-17 / FRW-1 / FRV-1, AXREL 32, IPA (Isopropyl alcohol)

- (1) Consult our factory when performing processes with cleaning solvents other than those listed above or deionized water.
- (2) The use of ozone depleting cleaning agents are not recommended in the interest of protecting the environment.
- (3) In the case of using ultrasonic cleaning, the terminals may be broken. Therefore, please test before using in mass production.

3. Usage environment of equipment

Avoid using equipment to which SP-Cap are fitted in the following environments.

- (1) In liquid, such as Water, Oil, Chemicals, or Organic solvent.
- (2) In direct sunlight, outdoors, or in dust.
- (3) In vapor, such as dew condensation water of resistive element, or water leakage, salty air, or air with a high concentration corrosive gas, such as Cl₂, H₂S, NH₃, SO₂, or NO₂.
- (4) In an environment where strong static electricity or electromagnetic waves exist.
- (5) Mounting or placing heat-generating components or inflammables, such as vinyl-coated wires, near these SP-Cap.
- (6) Sealing or coating of these SP-Cap or a printed circuit board on which these SP-Cap are mounted, with resin and other material.
- (7) Acid or alkaline environments.
- (8) Environment subject to excessive vibration and shock.

4. Storage

SP-Cap should be stored in a moisture proof environment. Storage conditions before and after opening the moisture proof packaging as follows.

(If these conditions are exceeded, the package may absorb moisture and there is a risk of damage to the exterior due to heat stress during mounting.)

[Environment of Storage]

Temperature: 5 °C to 30 °C without direct sunlight

Humidity : Less than 70 %

Maximum storage term before opening the package (2 years after manufactured)

Maximum storage condition after opening the package (7 days after opening)

SP-Cap should be all used within the storage term after opening the package.

5. Transportation

Take sufficient care during handling because excessive vibration, or shock can cause the reliability of the SP-Cap to decrease.

6. Emergency procedures

If the SP-Cap is overheated, the resin case may emit smoke. If this occurs, immediately switch off the unit's main power supply to stop operation. Keep your face and hands away from the SP-Cap the temperature may be high enough to cause the SP-Cap to ignite and burn.

7. Discarding

Since SP-Cap are composed of various metals and resins, treat them as industrial waste when arranging for their disposal.

The precautions for the use of functional polymer aluminum electrolytic capacitors follow the "Precautionary guidelines for the use of fixed aluminum electrolytic capacitors for electronic equipment", RCR- 2367B issued by EIAJ in March 2002. Please refer to the above guidelines for details.

◇ Intellectual property right

We, Panasonic Group are providing the product and service that customers can use without anxiety, and are working positively on the protection of our products under intellectual property rights.

Representative patents relating to SP-Cap are as follows :

US Patent No. 7136276

Line up

Series	Page	Part No.	Features	Low profile	Low ESR	Low ESL	High voltage	High Temperature	Category temperature range (°C)	Rated voltage (V.DC)	ESR (mΩ)	Capacitance (μF)
CX	21 to 22	EEFCX----	Standard				●		-55 to 105	2 to 35	12 to 40	15 to 560
CT	21 to 22	EEFCT----		●			●		-55 to 105	4 to 35	15 to 40	15 to 180
CS	21 to 22	EEFCS----		●			●		-55 to 105	4 to 35	15 to 40	10 to 120
SX	23 to 24	EEFSX----	Low ESR		●				-55 to 105	2 to 6.3	4.5 to 9	82 to 560
GX	25 to 26	EEFGX----	Super low ESR/High ripple current		●	●			-55 to 105	2 to 2.5	3	330 to 560
LX	27 to 28	EEFLX----	Low ESR/Low ESL		●	●			-55 to 105	2 to 2.5	4.5 to 6	330 to 560
ST	29 to 30	EEFST----	Low profile/Low ESR	●	●				-55 to 105	2 to 2.5	6	270 to 330
LT	29 to 30	EEFLT----	Low profile/Low ESR/Low ESL	●	●	●			-55 to 105	2 to 2.5	6	270 to 330
SS	29 to 30	EEFSS----	Low profile/Low ESR	●	●				-55 to 105	2 to 2.5	6	180 to 220
LS	29 to 30	EEFLS----	Low profile/Low ESR/Low ESL	●	●	●			-55 to 105	2 to 2.5	6	180 to 220
SR	29 to 30	EEFSR----	Low profile(1 mm max.)	●	●				-55 to 105	2 to 6.3	4.5 to 9	68 to 220
LR	29 to 30	EEFLR----	Low profile(1 mm max.)/Low ESL	●	●	●			-55 to 105	2 to 6.3	4.5 to 9	68 to 220
HX	31 to 32	EEFHX----	Guaranteed at 125 °C		●		●	●	-55 to 125	2 to 25	4.5 to 40	15 to 560

Diagram

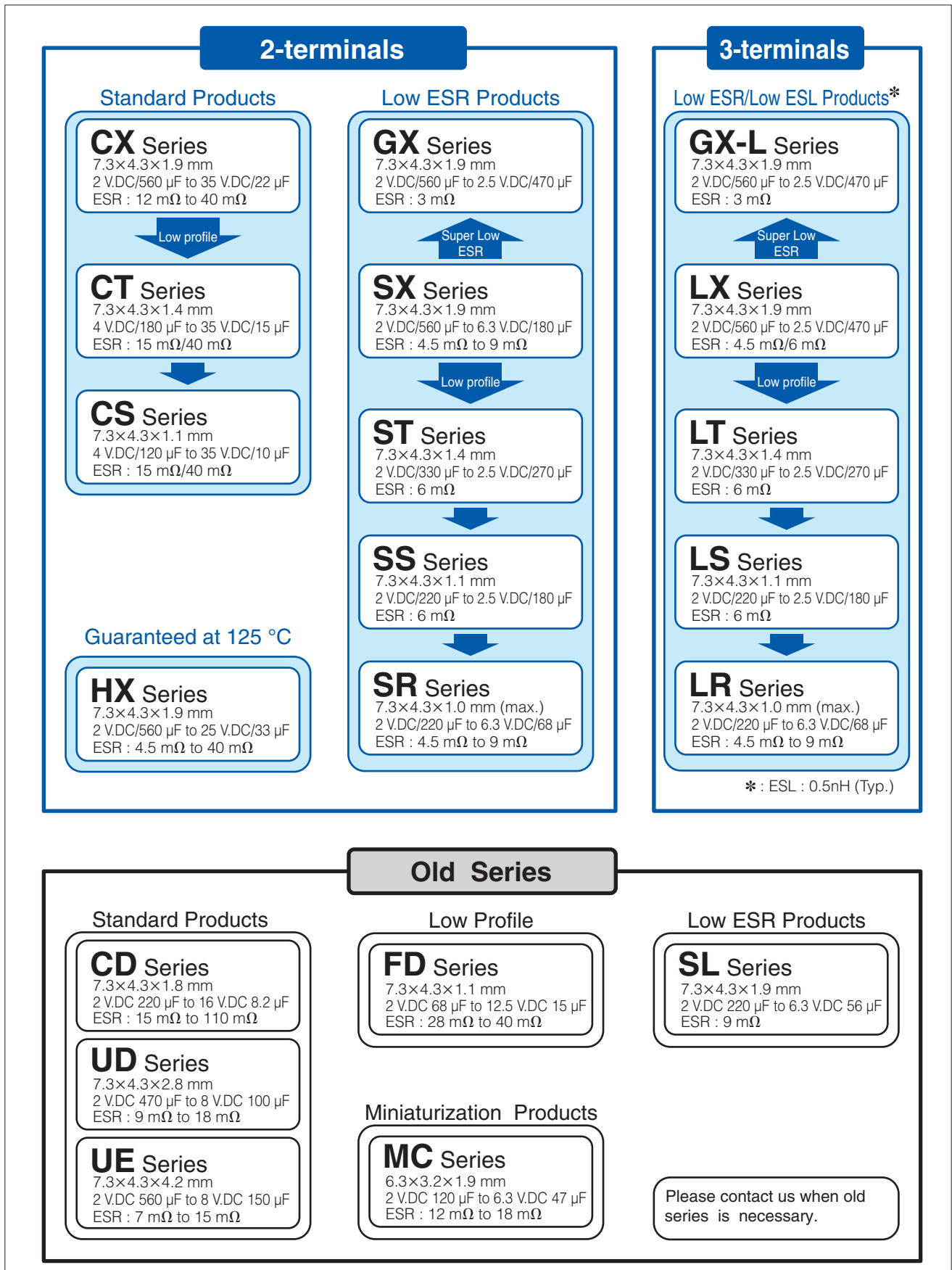

Mounting Specifications

- Recommendable reflow soldering

<Standard>

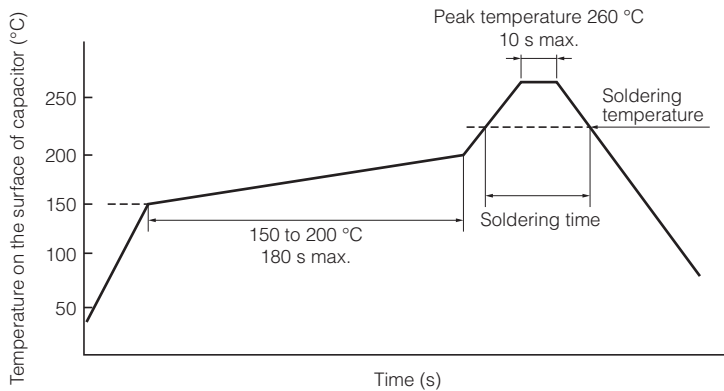

Reflow cycle : 3 max.

Soldering temperature and Soldering time

Temperature	Time
≥ 255 °C	30 s max.
≥ 230 °C	130 s max.
≥ 217 °C	150 s max.

Sp-Cap recommended profile condition of the IPC/J-STD-020D standard

<260 °C>

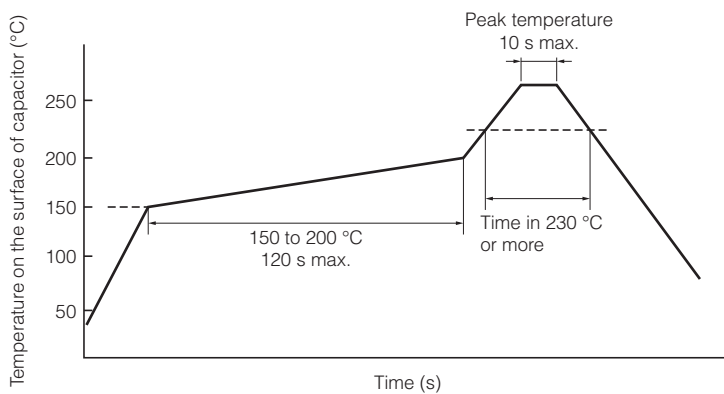

Reflow cycle : 2 max.

EX.)

Peak temperature	Time in 230 °C or more
260 °C, 10 s max.	40 s max.
250 °C, 10 s max.	60 s max.

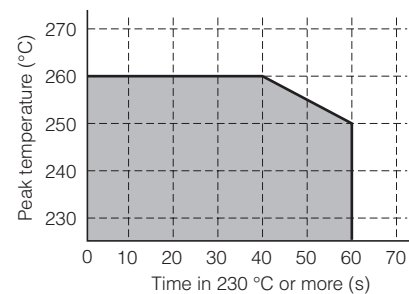

- Typical land pattern

For standard terminal (2-terminals)

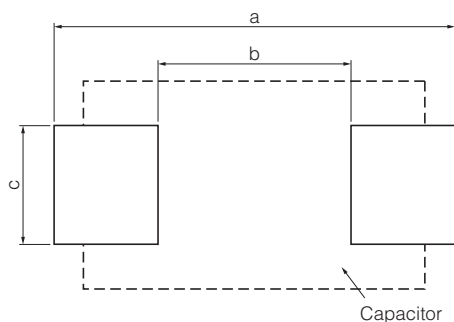

Unit : mm

Series	a	b	c
Standard (Except MC)	8.8	4.0	2.8
(MC)	7.2	2.6	2.2

● Typical land pattern

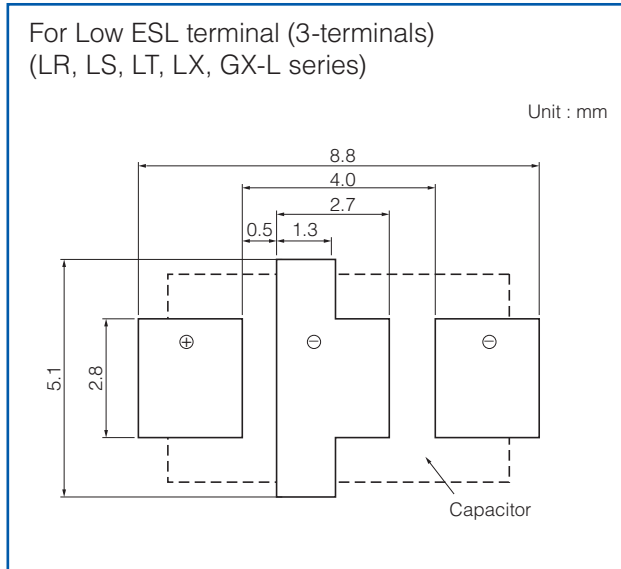

● VIA

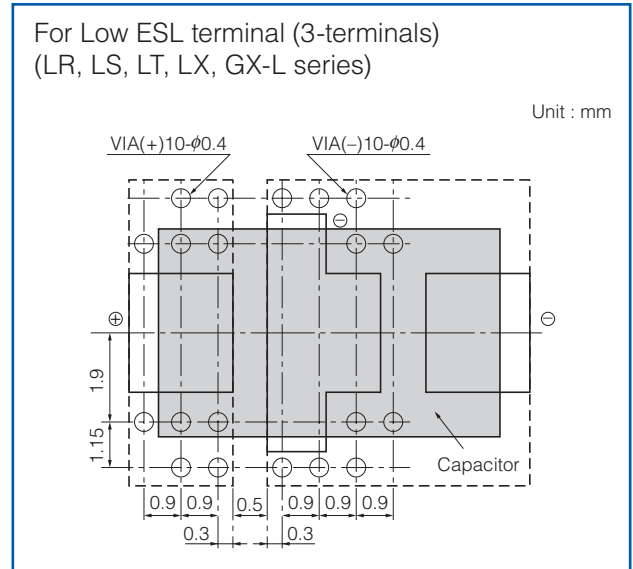

Packaging Specifications

● Reel Dimensions

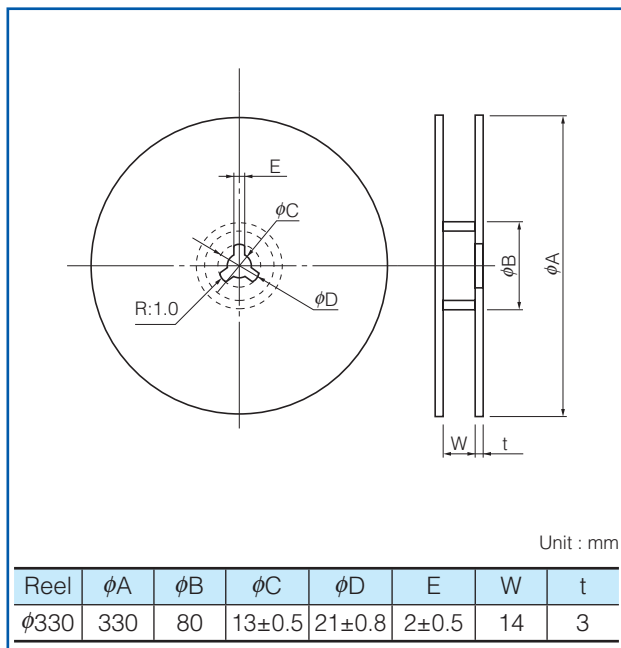

● Embossed Taping

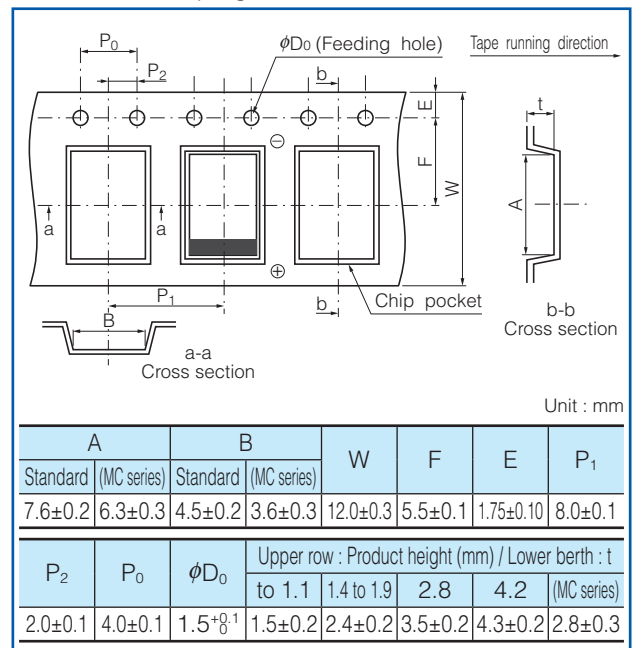

Packaging Box Dimensions

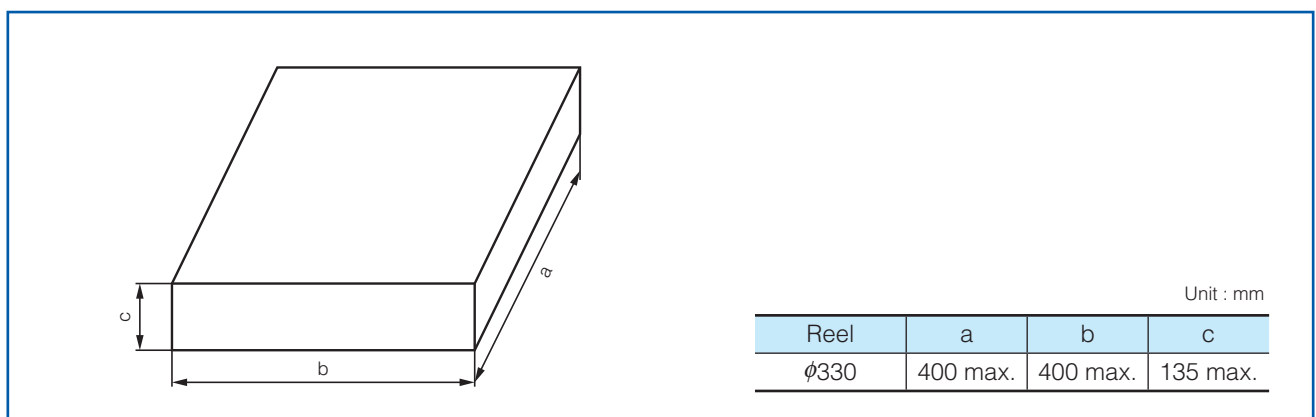

Surface Mount Type

SP-Cap

Series : **CS, CT, CX**



Features

- High voltage (35 V.DC max.)
- Low profile (Height 1.0 mm max.)
- High ripple current (5600 mAr.m.s. max.)
- RoHS compliance, Halogen free

Specifications

Series	CS	CT	CX	
Category temp. range	-55 °C to +105 °C			
Rated voltage range	4 V.DC to 35 V.DC		2 V.DC to 35 V.DC	
Nominal cap.range	10 µF to 120 µF	15 µF to 180 µF	15 µF to 560 µF	
Capacitance tolerance	±20 % (120 Hz / + 20 °C)			
DC leakage current	I ≤ 0.1 CV (µA) [2 V.DC to 6.3 V.DC, 2 minutes], I ≤ 0.3 CV (µA) [10 V.DC to 35 V.DC, 2 minutes]			
Dissipation factor (tan δ)	≤ 0.06 (120 Hz / + 20 °C)			
Surge voltage (V.DC)	Rated voltage × 1.25 [2 V.DC to 16 V.DC], × 1.15 [20 V.DC to 35 V.DC] (15 °C to 35 °C)			
Endurance	+105 °C, 2000 h, rated voltage applied			
	Capacitance change	Within ±20 % of the initial value		
	tan δ	≤ 2 times of the initial limit		
	DC leakage current	2 V.DC to 6.3 V DC : ≤ 3 times of the initial limit 10 V.DC to 35 V.DC : Within the initial limit		
Damp heat (Steady state)	+60 °C, 90 %, 500 h, No-applied voltage			
	Capacitance change of initial measurd value	2 V.DC to 2.5 V.DC	4 V.DC, 10 V.DC to 35 V.DC	6.3 V.DC
		+70 %, -20 %	+60 %, -20 %	+50 %, -20 %
	tan δ	≤ 2 times of the initial limit		
DC leakage current	2 V.DC to 6.3 V.DC : Within the initial limit 10 V.DC to 35V DC : ≤ 3 times of the initial limit			

Marking

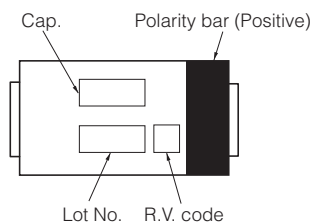

Rated voltage mark

d	2 V.DC	j	6.3 V.DC	D	20 V.DC
e	2.5 V.DC	A	10 V.DC	E	25 V.DC
g	4 V.DC	C	16 V.DC	V	35 V.DC

Dimensions (not to scale)

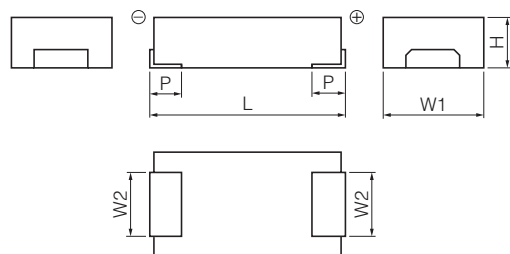

Unit : mm

Series	L±0.2	W1±0.2	W2±0.1	H±0.1	P±0.3
CS	7.3	4.3	2.4	1.1	1.3
CT	7.3	4.3	2.4	1.4	1.3
CX	7.3	4.3	2.4	1.9	1.3

* Externals of figure are the reference.

Characteristics list

								Reflow *3	<Standard>
Series	Rated voltage (V.DC)	Capacitance (±20%) (μF)	Case size (mm)			Specification		Part number	Min.*4 Packaging Q'ty (pcs)
			L	W	H	*1 Ripple current (mAr.m.s.)	*2 ESR (mΩ max.)		
CS	4	120	7.3	4.3	1.1	5100	15	EEFCS0G121R	3500
	6.3	68	7.3	4.3	1.1	5100	15	EEFCS0J680R	3500
	10	47	7.3	4.3	1.1	3200	40	EEFCS1A470R	3500
	16	15	7.3	4.3	1.1	3200	40	EEFCS1C150R	3500
		22	7.3	4.3	1.1	3200	40	EEFCS1C220R	3500
		33	7.3	4.3	1.1	3200	40	EEFCS1C330R	3500
	20	10	7.3	4.3	1.1	3200	40	EEFCS1D100R	3500
		15	7.3	4.3	1.1	3200	40	EEFCS1D150R	3500
		22	7.3	4.3	1.1	3200	40	EEFCS1D220R	3500
	25	10	7.3	4.3	1.1	3200	40	EEFCS1E100R	3500
15		7.3	4.3	1.1	3200	40	EEFCS1E150R	3500	
35	10	7.3	4.3	1.1	3200	40	EEFCS1V100R	3500	
CT	4	180	7.3	4.3	1.4	5100	15	EEFCT0G181R	3500
	6.3	100	7.3	4.3	1.4	5100	15	EEFCT0J101R	3500
	10	68	7.3	4.3	1.4	3200	40	EEFCT1A680R	3500
	16	47	7.3	4.3	1.4	3200	40	EEFCT1C470R	3500
	20	33	7.3	4.3	1.4	3200	40	EEFCT1D330R	3500
		47	7.3	4.3	1.4	3200	40	EEFCT1D470R	3500
	25	22	7.3	4.3	1.4	3200	40	EEFCT1E220R	3500
	35	15	7.3	4.3	1.4	3200	40	EEFCT1V150R	3500

*1: Ripple current (100 kHz/ +45°C), *2: ESR (100 kHz/+20 °C)

*3: Please refer to the page of "Mounting Specifications".

*4: Please contact us when 500 pcs packing is necessary.

Characteristics list

Reflow *3 <Standard>

Series	Rated voltage (V.DC)	Capacitance (±20%) (μF)	Case size (mm)			Specification		Part number	Min.*4 Packaging Q'ty (pcs)
			L	W	H	Ripple current *1 (mA r.m.s.)	ESR *2 (mΩ max.)		
CX	2	220	7.3	4.3	1.9	5100	15	EEFCX0D221R	3500
		270	7.3	4.3	1.9	5600	12	EEFCX0D271XR	3500
		330	7.3	4.3	1.9	5100	15	EEFCX0D331R	3500
			7.3	4.3	1.9	5600	12	EEFCX0D331XR	3500
		390	7.3	4.3	1.9	5100	15	EEFCX0D391R	3500
		470	7.3	4.3	1.9	5100	15	EEFCX0D471R	3500
	560	7.3	4.3	1.9	5100	15	EEFCX0D561R	3500	
	2.5	220	7.3	4.3	1.9	5100	15	EEFCX0E221R	3500
		330	7.3	4.3	1.9	5100	15	EEFCX0E331R	3500
		390	7.3	4.3	1.9	5100	15	EEFCX0E391R	3500
		470	7.3	4.3	1.9	5100	15	EEFCX0E471R	3500
	4	150	7.3	4.3	1.9	5100	15	EEFCX0G151R	3500
			7.3	4.3	1.9	5100	15	EEFCX0G181R	3500
		220	7.3	4.3	1.9	5100	15	EEFCX0G221R	3500
			7.3	4.3	1.9	5600	12	EEFCX0G221XR	3500
		270	7.3	4.3	1.9	5100	15	EEFCX0G271R	3500
		330	7.3	4.3	1.9	5100	15	EEFCX0G331R	3500
	6.3	100	7.3	4.3	1.9	5100	15	EEFCX0J101R	3500
		120	7.3	4.3	1.9	5100	15	EEFCX0J121R	3500
		150	7.3	4.3	1.9	5100	15	EEFCX0J151R	3500
			7.3	4.3	1.9	5600	12	EEFCX0J151XR	3500
		180	7.3	4.3	1.9	5100	15	EEFCX0J181R	3500
		220	7.3	4.3	1.9	5100	15	EEFCX0J221R	3500
	10	47	7.3	4.3	1.9	3200	40	EEFCX1A470R	3500
		68	7.3	4.3	1.9	3200	40	EEFCX1A680R	3500
		100	7.3	4.3	1.9	3200	40	EEFCX1A101R	3500
	16	15	7.3	4.3	1.9	3200	40	EEFCX1C150R	3500
		22	7.3	4.3	1.9	3200	40	EEFCX1C220R	3500
		33	7.3	4.3	1.9	3200	40	EEFCX1C330R	3500
		47	7.3	4.3	1.9	3200	40	EEFCX1C470R	3500
		68	7.3	4.3	1.9	3200	40	EEFCX1C680R	3500
	20	22	7.3	4.3	1.9	3200	40	EEFCX1D220R	3500
		33	7.3	4.3	1.9	3200	40	EEFCX1D330R	3500
		47	7.3	4.3	1.9	3200	40	EEFCX1D470R	3500
		56	7.3	4.3	1.9	3200	40	EEFCX1D560R	3500
	25	15	7.3	4.3	1.9	3200	40	EEFCX1E150R	3500
22		7.3	4.3	1.9	3200	40	EEFCX1E220R	3500	
33		7.3	4.3	1.9	3200	40	EEFCX1E330R	3500	
35	15	7.3	4.3	1.9	3200	40	EEFCX1V150R	3500	
	22	7.3	4.3	1.9	3200	40	EEFCX1V220R	3500	

*1: Ripple current (100 kHz/ +45°C), *2: ESR (100 kHz/+20°C)

*3: Please refer to the page of "Mounting Specifications".

*4: Please contact us when 500 pcs packing is necessary.

Temperature compensation multipliers for ripple current

	Temp.	T ≤ 45 °C	45 °C < T ≤ 85 °C	85 °C < T ≤ 105 °C
2 V.DC to 6.3 V.DC	Coefficient	1.0	0.7	0.25
10 V.DC to 35 V.DC		1.0	0.8	0.5

Surface Mount Type **SP-Cap**

Series : **SX (Low ESR Products)**



Features

- Large capacitance (560 μ F max.)
- Low ESR (4.5 m Ω to 9 m Ω)
- High ripple current (8500 mAr.m.s. max.)
- RoHS compliance, Halogen free

Specifications

Series	SX			
Category temp. range	-55 °C to +105 °C			
Rated voltage range	2 V.DC to 6.3 V.DC			
Nominal cap.range	82 μ F to 560 μ F			
Capacitance tolerance	\pm 20 % (120 Hz/+20 °C)			
DC leakage current	$I \leq 0.1 CV$ (μ A) 2 minutes			
Dissipation factor (tan δ)	≤ 0.06 (120 Hz/+20 °C)			
Surge voltage (V.DC)	Rated voltage \times 1.25 (15 °C to 35 °C)			
Endurance	+105 °C, 2000 h, rated voltage applied			
	Capacitance change	Within \pm 20 % of the initial value		
	tan δ	≤ 2 times of the initial limit		
	DC leakage current	≤ 3 times of the initial limit		
Damp heat (Steady state)	+60 °C, 90 %, 500 h, No-applied voltage			
	Capacitance change of initial measurd value	2 to 2.5 V.DC	4 V.DC	6.3 V.DC
		+70 %, -20 %	+60 %, -20 %	+50 %, -20 %
	tan δ	≤ 2 times of the initial limit		
DC leakage current	Within the initial limit			

Marking

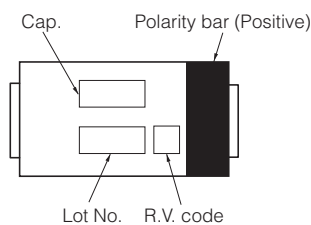

Rated voltage mark

d	2 V.DC
e	2.5 V.DC
g	4 V.DC
j	6.3 V.DC

Dimensions (not to scale)

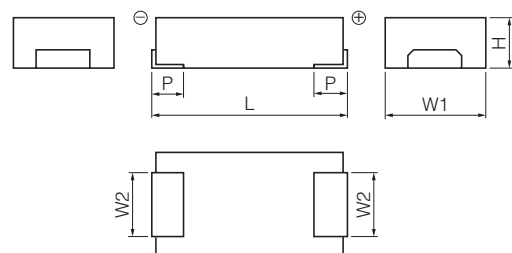

Unit : mm

Series	L \pm 0.2	W1 \pm 0.2	W2 \pm 0.1	H \pm 0.1	P \pm 0.3
SX	7.3	4.3	2.4	1.9	1.3

* Externals of figure are the reference.

Characteristics list

Reflow *3 <Standard>

Series	Rated voltage (V.DC)	Capacitance (±20%) (μF)	Case size (mm)			Specification		Part number	Min.*4 Packaging Q'ty (pcs)
			L	W	H	*1 Ripple current (mAr.m.s.)	*2 ESR (mΩ max.)		
SX	2	180	7.3	4.3	1.9	6300	9	EEFSX0D181ER	3500
		220	7.3	4.3	1.9	6300	9	EEFSX0D221ER	3500
		270	7.3	4.3	1.9	6300	9	EEFSX0D271ER	3500
			7.3	4.3	1.9	7500	6	EEFSX0D271XE	3500
			7.3	4.3	1.9	8500	4.5	EEFSX0D271E4	3500
		330	7.3	4.3	1.9	6300	9	EEFSX0D331ER	3500
			7.3	4.3	1.9	7500	6	EEFSX0D331XE	3500
			7.3	4.3	1.9	8500	4.5	EEFSX0D331E4	3500
		390	7.3	4.3	1.9	6300	9	EEFSX0D391ER	3500
			7.3	4.3	1.9	7500	6	EEFSX0D391XE	3500
	7.3		4.3	1.9	8500	4.5	EEFSX0D391E4	3500	
	470	7.3	4.3	1.9	6300	9	EEFSX0D471ER	3500	
		7.3	4.3	1.9	7500	6	EEFSX0D471XE	3500	
		7.3	4.3	1.9	8500	4.5	EEFSX0D471E4	3500	
	560	7.3	4.3	1.9	8500	4.5	EEFSX0D561E4	3500	
	2.5	150	7.3	4.3	1.9	6300	9	EEFSX0E151ER	3500
		180	7.3	4.3	1.9	6300	9	EEFSX0E181ER	3500
		220	7.3	4.3	1.9	6300	9	EEFSX0E221ER	3500
			7.3	4.3	1.9	7000	7	EEFSX0E221E7	3500
		270	7.3	4.3	1.9	7000	7	EEFSX0E271E7	3500
		330	7.3	4.3	1.9	6300	9	EEFSX0E331ER	3500
			7.3	4.3	1.9	7500	6	EEFSX0E331XE	3500
			7.3	4.3	1.9	8500	4.5	EEFSX0E331E4	3500
		390	7.3	4.3	1.9	6300	9	EEFSX0E391ER	3500
			7.3	4.3	1.9	7500	6	EEFSX0E391XE	3500
			7.3	4.3	1.9	8500	4.5	EEFSX0E391E4	3500
		470	7.3	4.3	1.9	6300	9	EEFSX0E471ER	3500
			7.3	4.3	1.9	7500	6	EEFSX0E471XE	3500
			7.3	4.3	1.9	8500	4.5	EEFSX0E471E4	3500
	4	82	7.3	4.3	1.9	6300	9	EEFSX0G820ER	3500
100		7.3	4.3	1.9	6300	9	EEFSX0G101ER	3500	
150		7.3	4.3	1.9	6300	9	EEFSX0G151ER	3500	
		7.3	4.3	1.9	7000	7	EEFSX0G151E7	3500	
180		7.3	4.3	1.9	6300	9	EEFSX0G181ER	3500	
220		7.3	4.3	1.9	6300	9	EEFSX0G221ER	3500	
270	7.3	4.3	1.9	6300	9	EEFSX0G271ER	3500		
6.3	120	7.3	4.3	1.9	7000	7	EEFSX0J121E7	3500	
	150	7.3	4.3	1.9	6300	9	EEFSX0J151ER	3500	
	180	7.3	4.3	1.9	6300	9	EEFSX0J181ER	3500	

*1: Ripple current (100 kHz/ +45°C), *2: ESR (100 kHz/+20°C)

*3: Please refer to the page of "Mounting Specifications".

*4: Please contact us when 500 pcs packing is necessary.

Temperature compensation multipliers for ripple current

Temp.	T ≤ 45 °C	45 °C < T ≤ 85 °C	85 °C < T ≤ 105 °C
Coefficient	1.0	0.7	0.25

Surface Mount Type **SP-Cap**

Series : **GX (Super Low ESR Products)**

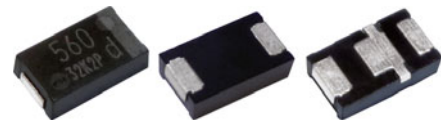

Features

- Large capacitance (560 μ F max.)
- Super Low ESR (3 m Ω max.)
- Low ESL (3-terminals : 50 % less than 2-terminals) [Suffix : L]
- High ripple current (10200 mAr.m.s. max.)
- RoHS compliance, Halogen free

Specifications

Series	GX	
Category temp. range	-55 °C to +105 °C	
Rated voltage range	2 V.DC to 2.5 V.DC	
Nominal cap.range	330 μ F to 560 μ F	
Capacitance tolerance	\pm 20 % (120 Hz/+20 °C)	
DC leakage current	$I \leq 0.1 CV$ (μ A) 2 minutes	
Dissipation factor (tan δ)	≤ 0.06 (120 Hz/+20 °C)	
Surge voltage (V.DC)	Rated voltage \times 1.25 (15 °C to 35 °C)	
Endurance	+105 °C, 2000 h, rated voltage applied	
	Capacitance change	Within \pm 20 % of the initial value
	tan δ	≤ 2 times of the initial limit
	DC leakage current	≤ 3 times of the initial limit
Damp heat (Steady state)	+60 °C, 90 %, 500 h, No-applied voltage	
	Capacitance change of initial measurd value	2 V.DC to 2.5 V.DC +70 %, -20 %
	tan δ	≤ 2 times of the initial limit
	DC leakage current	Within the initial limit

Marking

Rated voltage mark	
d	2 V.DC
e	2.5 V.DC

Dimensions (not to scale)

2 terminals

Unit : mm

Series	L \pm 0.2	W1 \pm 0.2	W2 \pm 0.1	H \pm 0.1	P \pm 0.3
GX	7.3	4.3	2.4	1.9	1.3

* Externals of figure are the reference.

3 terminals

Unit : mm

Series	L \pm 0.2	W1 \pm 0.2	W2 \pm 0.1	H \pm 0.1	P1 \pm 0.3	P2 \pm 0.1	P3 \pm 0.2	P4 \pm 0.2
GX	7.3	4.3	2.4	1.9	1.3	1.1	0.7	1.4

* Externals of figure are the reference.

Characteristics list

											Reflow *3	<Standard>
Series	Rated voltage (V.DC)	Capacitance (±20%) (μF)	Case size (mm)			Specification		The number of terminals		Part number	Min.*4 Packaging Q'ty (pcs)	
			L	W	H	*1 Ripple current (mA r.m.s.)	*2 ESR (mΩ max.)	2	3			
GX	2	330	7.3	4.3	1.9	10200	3	○		EEFGX0D331R	3500	
		470	7.3	4.3	1.9	10200	3	○		EEFGX0D471R	3500	
			7.3	4.3	1.9	10200	3		○	EEFGX0D471L	3500	
		560	7.3	4.3	1.9	10200	3	○		EEFGX0D561R	3500	
	7.3		4.3	1.9	10200	3		○	EEFGX0D561L	3500		
	2.5	470	7.3	4.3	1.9	10200	3	○		EEFGX0E471R	3500	
			7.3	4.3	1.9	10200	3		○	EEFGX0E471L	3500	

*1: Ripple current (100 kHz/ +45°C), *2: ESR (100 kHz/+20 °C)

*3: Please refer to the page of "Mounting Specifications".

*4: Please contact us when 500 pcs packing is necessary.

Temperature compensation multipliers for ripple current

Temp.	$T \leq 45\text{ °C}$	$45\text{ °C} < T \leq 85\text{ °C}$	$85\text{ °C} < T \leq 105\text{ °C}$
Coefficient	1.0	0.7	0.25

Surface Mount Type **SP-Cap**

Series : **LX (Low ESR / Low ESL Products)**



Features

- Large capacitance (560 μ F max.)
- Low ESR (4.5 m Ω , 6 m Ω)
- Low ESL (3-terminals : 50 % less than 2-terminals)
- High ripple current (8500 mAr.m.s. max.)
- RoHS compliance, Halogen free

Specifications

Series	LX	
Category temp. range	-55 °C to +105 °C	
Rated voltage range	2 V.DC to 2.5 V.DC	
Nominal cap.range	330 μ F to 560 μ F	
Capacitance tolerance	± 20 % (120 Hz/+20 °C)	
DC leakage current	$I \leq 0.1$ CV (μ A) 2 minutes	
Dissipation factor (tan δ)	≤ 0.06 (120 Hz/+20 °C)	
Surge voltage (V.DC)	Rated voltage \times 1.25 (15 °C to 35 °C)	
Endurance	+105 °C, 2000 h, rated voltage applied	
	Capacitance change	Within ± 20 % of the initial value
	tan δ	≤ 2 times of the initial limit
	DC leakage current	≤ 3 times of the initial limit
Damp heat (Steady state)	+60 °C, 90 %, 500 h, No-applied voltage	
	Capacitance change of initial measurd value	2 V.DC to 2.5 V.DC +70 %, -20 %
	tan δ	≤ 2 times of the initial limit
	DC leakage current	Within the initial limit

Marking

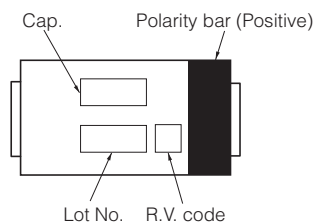

Rated voltage mark

d	2 V.DC
e	2.5 V.DC

Dimensions (not to scale)

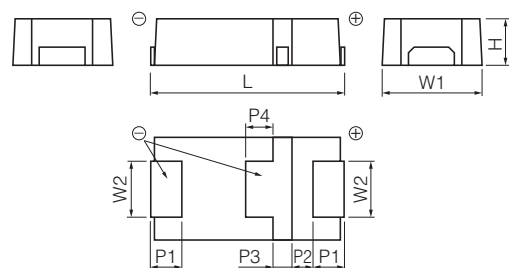

Unit : mm

Series	L ± 0.2	W1 ± 0.2	W2 ± 0.1	H ± 0.1	P1 ± 0.3	P2 ± 0.1	P3 ± 0.2	P4 ± 0.2
LX	7.3	4.3	2.4	1.9	1.3	1.1	0.7	1.4

* Externals of figure are the reference.

Characteristics list

		Reflow *3		<Standard>					
Series	Rated voltage (V.DC)	Capacitance (±20%) (μF)	Case size (mm)			Specification		Part number	Min.*4 Packaging Q'ty (pcs)
			L	W	H	*1 Ripple current (mAr.m.s.)	*2 ESR (mΩ max.)		
LX	2	330	7.3	4.3	1.9	7500	6	EEFLX0D331R	3500
			7.3	4.3	1.9	8500	4.5	EEFLX0D331R4	3500
		470	7.3	4.3	1.9	7500	6	EEFLX0D471R	3500
			7.3	4.3	1.9	8500	4.5	EEFLX0D471R4	3500
		560	7.3	4.3	1.9	7500	6	EEFLX0D561R	3500
			7.3	4.3	1.9	8500	4.5	EEFLX0D561R4	3500
	2.5	330	7.3	4.3	1.9	7500	6	EEFLX0E331R	3500
			7.3	4.3	1.9	8500	4.5	EEFLX0E331R4	3500
		470	7.3	4.3	1.9	7500	6	EEFLX0E471R	3500
			7.3	4.3	1.9	8500	4.5	EEFLX0E471R4	3500

*1: Ripple current (100 kHz/ +45°C), *2: ESR (100 kHz/+20 °C)

*3: Please refer to the page of "Mounting Specifications".

*4: Please contact us when 500 pcs packing is necessary.

Temperature compensation multipliers for ripple current

Temp.	$T \leq 45\text{ }^{\circ}\text{C}$	$45\text{ }^{\circ}\text{C} < T \leq 85\text{ }^{\circ}\text{C}$	$85\text{ }^{\circ}\text{C} < T \leq 105\text{ }^{\circ}\text{C}$
Coefficient	1.0	0.7	0.25

Surface Mount Type **SP-Cap**

Series : **SR, LR, SS, LS, ST, LT**



Features

- Low profile (Height 1.0 mm max.)
- Low ESR (4.5 mΩ to 9 mΩ)
- Low ESL (3-terminals : 50% less than 2-terminals) [LR, LS, LT series]
- High ripple current (8500 mAr.m.s. max.)
- RoHS compliance, Halogen free

Specifications

Series	SR	LR	SS	LS	ST	LT	
Category temp. Range	-55 °C to +105 °C						
Rated voltage range	2 V.DC to 6.3 V.DC		2 V.DC to 2.5 V.DC				
Nominal cap.Range	68 μF to 220μF		180 μF to 220μF		270 μF to 330 μF		
Capacitance tolerance	±20 % (120 Hz / + 20 °C)						
DC leakage current	$I \leq 0.1 CV (\mu A)$ 2 minutes						
Dissipation factor (tan δ)	≤ 0.06 (120 Hz/+20 °C)						
Surge voltage (V.DC)	Rated voltage × 1.25 (15 °C to 35 °C)						
Endurance	+105 °C, 2000 h, rated voltage applied						
	Capacitance change	Within ±20 % of the initial value					
	tan δ	≤ 2 times of the initial limit					
	DC leakage current	≤ 3 times of the initial limit					
Damp heat (Steady state)	+60 °C, 90 %, 500 h, No-applied voltage						
	Capacitance change of initial measurd value	2 V.DC to 2.5 V.DC +70 %, -20 %		4 V.DC +60 %, -20 %		6.3 V.DC +50 %, -20 %	
	tan δ	≤ 2 times of the initial limit					
	DC leakage current	Within the initial limit					

Marking

d	2 V.DC
e	2.5 V.DC
g	4 V.DC
j	6.3 V.DC

Dimensions (not to scale)

SR, SS, ST series

Unit : mm

Series	L±0.2	W1±0.2	W2±0.1	H±0.1	P±0.3
SR	7.3	4.3	2.4	1.0*1	1.3
SS	7.3	4.3	2.4	1.1	1.3
ST	7.3	4.3	2.4	1.4	1.3

* Externals of figure are the reference. *1 : Maximum

LR, LS, LT series

Unit : mm

Series	L±0.2	W1±0.2	W2±0.1	H±0.1	P1±0.3	P2±0.1	P3±0.2	P4±0.2
LR	7.3	4.3	2.4	1.0*1	1.3	1.1	0.7	1.4
LS	7.3	4.3	2.4	1.1	1.3	1.1	0.7	1.4
LT	7.3	4.3	2.4	1.4	1.3	1.1	0.7	1.4

* Externals of figure are the reference. *1 : Maximum

Characteristics list

											Reflow *3	<Standard>
Series	Rated voltage (V.DC)	Capacitance (±20%) (μF)	Case size (mm)			Specification		The number of terminals		Part number	Min.*4 Packaging Q'ty (pcs)	
			L	W	H	*1	*2	2	3			
						Ripple current (mA r.m.s.)	ESR (mΩ max.)					
SR	2	220	7.3	4.3	1.0 max.	7500	6	○		EEFSR0D221R	3500	
			7.3	4.3	1.0 max.	8500	4.5	○		EEFSR0D221R4	3500	
	2.5	180	7.3	4.3	1.0 max.	7500	6	○		EEFSR0E181R	3500	
			7.3	4.3	1.0 max.	8500	4.5	○		EEFSR0E181R4	3500	
	4	120	7.3	4.3	1.0 max.	6300	9	○		EEFSR0G121R	3500	
			7.3	4.3	1.0 max.	6300	9	○		EEFSR0J680R	3500	
LR	2	220	7.3	4.3	1.0 max.	7500	6		○	EEFLR0D221R	3500	
			7.3	4.3	1.0 max.	8500	4.5		○	EEFLR0D221R4	3500	
	2.5	180	7.3	4.3	1.0 max.	7500	6		○	EEFLR0E181R	3500	
			7.3	4.3	1.0 max.	8500	4.5		○	EEFLR0E181R4	3500	
	4	120	7.3	4.3	1.0 max.	6300	9		○	EEFLR0G121R	3500	
			7.3	4.3	1.0 max.	6300	9		○	EEFLR0J680R	3500	
SS	2	220	7.3	4.3	1.1	7500	6	○		EEFSS0D221R	3500	
			7.3	4.3	1.1	7500	6	○		EEFSS0E181R	3500	
LS	2	220	7.3	4.3	1.1	7500	6		○	EEFLS0D221R	3500	
			7.3	4.3	1.1	7500	6		○	EEFLS0E181R	3500	
ST	2	330	7.3	4.3	1.4	7500	6	○		EEFST0D331R	3500	
			7.3	4.3	1.4	7500	6	○		EEFST0E271R	3500	
LT	2	330	7.3	4.3	1.4	7500	6		○	EEFLT0D331R	3500	
			7.3	4.3	1.4	7500	6		○	EEFLT0E271R	3500	

*1: Ripple current (100 kHz/ +45°C), *2: ESR (100 kHz/+20 °C)

*3: Please refer to the page of "Mounting Specifications".

*4: Please contact us when 500 pcs packing is necessary.

Temperature compensation multipliers for ripple current

Temp.	$T \leq 45\text{ }^{\circ}\text{C}$	$45\text{ }^{\circ}\text{C} < T \leq 85\text{ }^{\circ}\text{C}$	$85\text{ }^{\circ}\text{C} < T \leq 105\text{ }^{\circ}\text{C}$
Coefficient	1.0	0.7	0.25

Surface Mount Type **SP-Cap**

Series : **HX (Guaranteed at 125 °C)**



Features

- Endurance 125 °C 1000 h
- High voltage & Large capacitance (2 V.DC 560 μF to 25 V.DC 33 μF)
- Low ESR (4.5 mΩ max.)
- RoHS compliance, Halogen free

Specifications

Series	HX	
Category temp. range	-55 °C to +125 °C	
Rated voltage range	2 V.DC to 2.5 V.DC, 10 V.DC to 25 V.DC	
Category voltage range	1.6 V.DC to 2 V.DC, 8 V.DC to 20 V.DC	
Nominal cap.range	15 μF to 560 μF	
Capacitance tolerance	±20 % (120 Hz/+20 °C)	
DC leakage current	2 V.DC to 2.5 V.DC : I ≤ 0.1 CV (μA) 2 minutes, 10 V.DC to 25 V.DC : I ≤ 0.3 CV (μA) 2 minutes	
Dissipation factor (tan δ)	≤ 0.1 (120 Hz/+20 °C)	
Surge voltage (V.DC)	Rated voltage × 1.25 [2 V.DC to 16 V.DC], × 1.15 [20 V.DC to 25 V.DC](15 °C to 35 °C)	
Endurance	+125 °C, 1000 h, Category voltage applied	
	Capacitance change	Within ±20 % of the initial value
	tan δ	≤ 2 times of the initial limit
	DC leakage current	Within the initial limit
Damp heat (Steady state)	After storing for 500 hours at +60 °C, 90 %	
	Capacitance change of initial measurd value	2 V.DC to 2.5 V.DC : +70 %, -20 % 10 V.DC to 25 V.DC : +60 %, -20 %
	tan δ	≤ 2 times of the initial limit
	DC leakage current	2 V.DC to 2.5 V.DC : Within the initial limit 10 V.DC to 25V DC : ≤ 3 times of the initial limit

Marking

Cap. Polarity bar (Positive)

Lot No. R.V. code

Rated voltage mark

d	2 V.DC	C	16 V.DC
e	2.5 V.DC	D	20 V.DC
A	10 V.DC	E	25 V.DC

Dimensions (not to scale)

Unit : mm

Series	L±0.2	W1±0.2	W2±0.1	H±0.1	P±0.3
HX	7.3	4.3	2.4	1.9	1.3

* Externals of figure are the reference.

Characteristics list

Reflow *3 <Standard>

Series	Rated voltage [105 °C] (V.DC)	Category voltage [125 °C] (V.DC)	Capacitance (±20 %) (μF)	Case size (mm)			Specification		Part number	Min.*4 Packaging Q'ty (pcs)
				L	W	H	*1 Ripple current (mAr.m.s.)	*2 ESR (mΩ max.)		
HX	2	1.6	470	7.3	4.3	1.9	5100	15	EEFHX0D471R	3500
				7.3	4.3	1.9	6300	9	EEFHX0D471R9	3500
				7.3	4.3	1.9	7500	6	EEFHX0D471R6	3500
			560	7.3	4.3	1.9	8500	4.5	EEFHX0D471R4	3500
				7.3	4.3	1.9	5100	15	EEFHX0D561R	3500
				7.3	4.3	1.9	8500	4.5	EEFHX0D561R4	3500
	2.5	2	330	7.3	4.3	1.9	5100	15	EEFHX0E331R	3500
				7.3	4.3	1.9	6300	9	EEFHX0E331R9	3500
				7.3	4.3	1.9	7500	6	EEFHX0E331R6	3500
				7.3	4.3	1.9	8500	4.5	EEFHX0E331R4	3500
			470	7.3	4.3	1.9	5100	15	EEFHX0E471R	3500
				7.3	4.3	1.9	6300	9	EEFHX0E471R9	3500
				7.3	4.3	1.9	7500	6	EEFHX0E471R6	3500
				7.3	4.3	1.9	8500	4.5	EEFHX0E471R4	3500
	10	8	47	7.3	4.3	1.9	3200	40	EEFHX1A470R	3500
			68	7.3	4.3	1.9	3200	40	EEFHX1A680R	3500
			100	7.3	4.3	1.9	3200	40	EEFHX1A101R	3500
	16	12.8	15	7.3	4.3	1.9	3200	40	EEFHX1C150R	3500
			22	7.3	4.3	1.9	3200	40	EEFHX1C220R	3500
			33	7.3	4.3	1.9	3200	40	EEFHX1C330R	3500
			47	7.3	4.3	1.9	3200	40	EEFHX1C470R	3500
			68	7.3	4.3	1.9	3200	40	EEFHX1C680R	3500
	20	16	22	7.3	4.3	1.9	3200	40	EEFHX1D220R	3500
			33	7.3	4.3	1.9	3200	40	EEFHX1D330R	3500
			47	7.3	4.3	1.9	3200	40	EEFHX1D470R	3500
			56	7.3	4.3	1.9	3200	40	EEFHX1D560R	3500
	25	20	15	7.3	4.3	1.9	3200	40	EEFHX1E150R	3500
			22	7.3	4.3	1.9	3200	40	EEFHX1E220R	3500
33			7.3	4.3	1.9	3200	40	EEFHX1E330R	3500	

*1: Ripple current (100 kHz/ +45°C), *2: ESR (100 kHz/+20 °C)

*3: Please refer to the page of "Mounting Specifications".

*4: Please contact us when 500 pcs packing is necessary.

Temperature compensation multipliers for ripple current

	Temp.	T ≤ 45 °C	45 °C < T ≤ 85 °C	85 °C < T ≤ 105 °C	125 °C < T
2 V.DC to 2.5 V.DC	Coefficient	1.0	0.7	0.25	0.25
10 V.DC to 25 V.DC		1.0	0.8	0.5	0.25

Ripple current should be controlled so that surface temperature of capacitor does not exceed the category temperature.

Surface Mount Type **SP-Cap**

Series: **FD, CD, UD, UE**

Old series

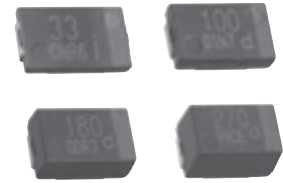

[Our Requests]

Since this series is old, we don't recommend you to adopt it but CX & SX series for your new design.

■ Features

- Low ESR
- Excellent Noise-absorbent Characteristics
- RoHS directive compliant

■ Specifications

Series & Size Code	FD	CD	UD	UE	
Category Temp. Range	-40 °C to +105 °C				
Rated Voltage Range	2 V.DC to 12.5 V.DC	2 V.DC to 16 V.DC	2 V.DC to 8 V.DC	2 V.DC to 8 V.DC	
Nominal Cap.Range	15 μF to 68 μF	2.2 μF to 220 μF	68 μF to 470 μF	100 μF to 560 μF	
Capacitance Tolerance	±20 %				
DC Leakage Current	Reflow 240 °C : I ≤ 0.06 CV (μA) 2minutes (2 V.DC to 4 V.DC) I ≤ 0.04 CV or 3 (μA) 2 minutes (6.3 V.DC to 16 V.DC) (Whichever is greater) Reflow 260 °C : I ≤ 0.1 CV (μA) 2 minutes				
tan δ	≤ 0.06 (120 Hz/+20 °C)		≤ 0.10 (120 Hz/+20 °C)		
Surge Voltage	Rated Voltage × 1.25 (15 °C to 35 °C)				
Endurance	After applying rated voltage for 1000 hours at 105 °C±2 °C, and then being stabilized at +20 °C, capacitor shall meet the following limits.				
	Capacitance change	±10% of initial measured value			
	tan δ	≤ Initial specified value			
	DC leakage current	≤ Initial specified value			
Moisture resistance	After storing for 500 hours at 60 °C, 90 %				
	Capacitance change of initial measured value	2, 2.5 V.DC	4 V.DC	6.3 V.DC	8 V.DC to 16 V.DC
		+70, -20 %	+60, -20 %	+50, -20 %	+40, -20 %
	tan δ	≤ 200 % of initial specified value			
DC leakage current	≤ Initial specified value				

■ Marking

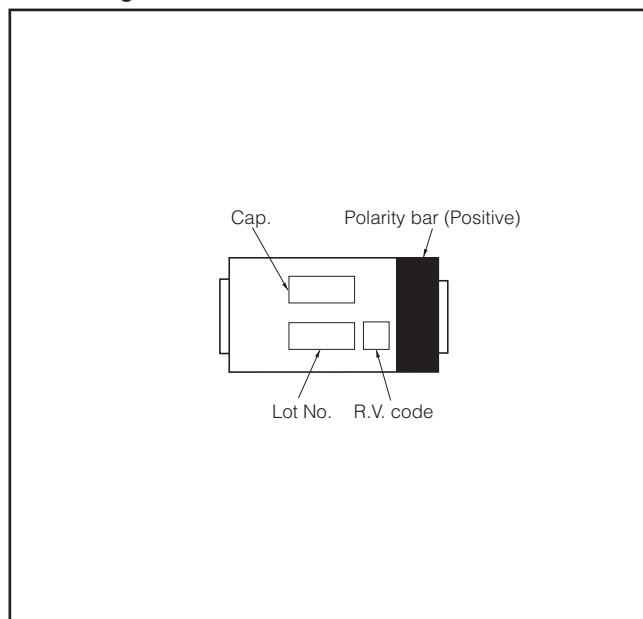

■ Dimensions in mm(not to scale)

(Unit : mm)

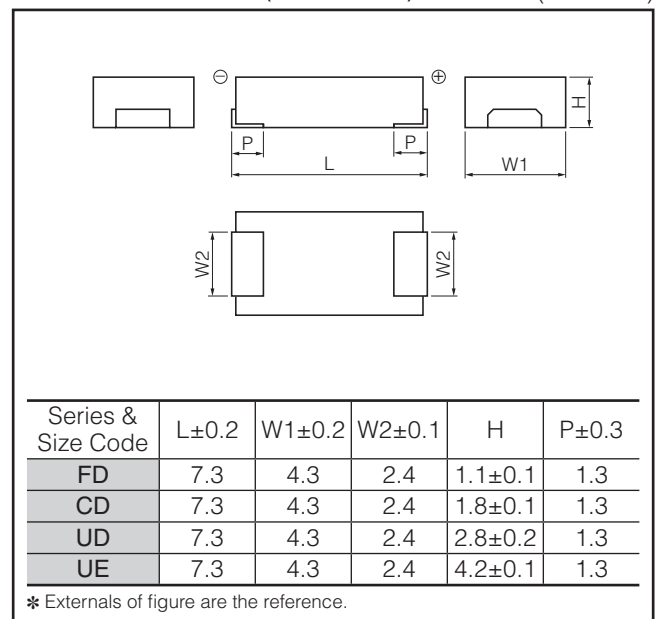

Design and specifications are each subject to change without notice. Ask factory for the current technical specifications before purchase and/or use. Should a safety concern arise regarding this product, please be sure to contact us immediately.

Standard Products

Reflow *3 <260 °C>

Series & Size Code	Rated Voltage (V.DC)	Capacitance (±20%) (μF)	Case Size			Specification		Part number	Reflow		Min. Packaging Qty (pcs)	
			L (mm)	W (mm)	H (mm)	*1 Ripple current (Ar.m.s.)	*2 ESR (mΩ max.)		*4 240 °C	260 °C		
FD	2	68	7.3	4.3	1.1	2.0	28	EEFFD0D680R	○	—	3500	
	2.5	56	7.3	4.3	1.1	2.0	28	EEFFD0E560R	○	—	3500	
	4	39	7.3	4.3	1.1	2.0	28	EEFFD0G390R	○	—	3500	
		47	7.3	4.3	1.1	2.0	28	EEFFD0G470R	○	—	3500	
	6.3	33	7.3	4.3	1.1	2.0	28	EEFFD0J330R	○	—	3500	
	8	22	7.3	4.3	1.1	2.0	28	EEFFD0K220R	○	—	3500	
	12.5	15	7.3	4.3	1.1	1.4	40	EEFFD1B150R	○	—	3500	
CD	2	100	7.3	4.3	1.8	2.5	18	EEFCD0D101ER	—	○	3500	
			7.3	4.3	1.8	2.7	15	EEFCD0D101XE	—	○	3500	
		120	7.3	4.3	1.8	2.5	18	EEFCD0D121ER	—	○	3500	
			7.3	4.3	1.8	2.7	15	EEFCD0D121XE	—	○	3500	
			150	7.3	4.3	1.8	2.5	18	EEFCD0D151ER	—	○	3500
			180	7.3	4.3	1.8	2.5	18	EEFCD0D181ER	—	○	3500
	2.5	82	7.3	4.3	1.8	2.5	18	EEFCD0E820ER	—	○	3500	
			7.3	4.3	1.8	2.7	15	EEFCD0E820XE	—	○	3500	
		100	7.3	4.3	1.8	2.5	18	EEFCD0E101ER	—	○	3500	
			7.3	4.3	1.8	2.7	15	EEFCD0E101XE	—	○	3500	
			120	7.3	4.3	1.8	2.5	18	EEFCD0E121ER	—	○	3500
			150	7.3	4.3	1.8	2.5	18	EEFCD0E151ER	—	○	3500
	4	56	7.3	4.3	1.8	2.5	18	EEFCD0G560ER	—	○	3500	
			7.3	4.3	1.8	2.7	15	EEFCD0G560XE	—	○	3500	
		68	7.3	4.3	1.8	2.5	18	EEFCD0G680ER	—	○	3500	
			7.3	4.3	1.8	2.7	15	EEFCD0G680XE	—	○	3500	
			82	7.3	4.3	1.8	2.5	18	EEFCD0G820ER	—	○	3500
			7.3	4.3	1.8	2.7	15	EEFCD0G820XE	—	○	3500	
	6.3	100	7.3	4.3	1.8	2.5	18	EEFCD0G101ER	—	○	3500	
			10	7.3	4.3	1.8	1.4	55	EEFCD0J100ER	—	○	3500
		22	7.3	4.3	1.8	1.6	40	EEFCD0J220ER	—	○	3500	
			33	7.3	4.3	1.8	2.0	28	EEFCD0J330ER	—	○	3500
			47	7.3	4.3	1.8	2.5	18	EEFCD0J470ER	—	○	3500
				7.3	4.3	1.8	2.7	15	EEFCD0J470XE	—	○	3500
		68	7.3	4.3	1.8	2.5	18	EEFCD0J680ER	—	○	3500	
			7.3	4.3	1.8	2.7	15	EEFCD0J680XE	—	○	3500	
		8	8.2	7.3	4.3	1.8	1.4	55	EEFCD0K8R2ER	—	○	3500
			15	7.3	4.3	1.8	1.6	40	EEFCD0K150ER	—	○	3500
			22	7.3	4.3	1.8	2.0	28	EEFCD0K220ER	—	○	3500
			33	7.3	4.3	1.8	2.5	18	EEFCD0K330ER	—	○	3500
	47		7.3	4.3	1.8	1.8	25	EEFCD0K470ER	—	○	3500	
	10	22	7.3	4.3	1.8	1.6	30	EEFCD1A220ER	—	○	3500	
		33	7.3	4.3	1.8	1.8	25	EEFCD1A330ER	—	○	3500	
		39	7.3	4.3	1.8	1.8	25	EEFCD1A390ER	—	○	3500	
	12.5	4.7	7.3	4.3	1.8	1.0	80	EEFCD1B4R7R	○	—	3500	
		10	7.3	4.3	1.8	1.0	60	EEFCD1B100R	○	—	3500	
		15	7.3	4.3	1.8	1.3	50	EEFCD1B150R	○	—	3500	
		22	7.3	4.3	1.8	1.6	30	EEFCD1B220R	○	—	3500	
	16	2.2	7.3	4.3	1.8	1.0	110	EEFCD1C2R2R	○	—	3500	
		4.7	7.3	4.3	1.8	1.0	80	EEFCD1C4R7R	○	—	3500	
		6.8	7.3	4.3	1.8	1.0	70	EEFCD1C6R8R	○	—	3500	
		8.2	7.3	4.3	1.8	1.3	45	EEFCD1C8R2R	○	—	3500	
	UD	2	330	7.3	4.3	2.8	3.0	15	EEFUD0D331ER	—	○	2000
				7.3	4.3	2.8	3.3	12	EEFUD0D331XE	—	○	2000
				7.3	4.3	2.8	3.4	9	EEFUD0D331LE	—	○	2000
			390	7.3	4.3	2.8	3.0	15	EEFUD0D391ER	—	○	2000
				7.3	4.3	2.8	3.4	9	EEFUD0D391LE	—	○	2000
				470	7.3	4.3	2.8	3.4	9	EEFUD0D471LE	—	○
2.5		220	7.3	4.3	2.8	3.0	15	EEFUD0E221ER	—	○	2000	
			7.3	4.3	2.8	3.3	12	EEFUD0E221XE	—	○	2000	
			7.3	4.3	2.8	3.4	9	EEFUD0E221LE	—	○	2000	
		270	7.3	4.3	2.8	3.0	15	EEFUD0E271ER	—	○	2000	
			7.3	4.3	2.8	3.4	9	EEFUD0E271LE	—	○	2000	

*1: Ripple current (100 kHz/ +20 to +105 °C), *2: ESR (100 kHz/+20 °C)

*3: Please refer to the page of "Mounting Specifications".

*4: Please contact Panasonic for details of allowable 240 °C reflow condition.

Design and specifications are each subject to change without notice. Ask factory for the current technical specifications before purchase and/or use. Should a safety concern arise regarding this product, please be sure to contact us immediately.

Standard Products

Reflow *3 <260 °C>

Series & Size Code	Rated Voltage (V.DC)	Capacitance (±20 %) (μF)	Case Size			Specification		Part number	Reflow		Min. Packaging Qty (pcs)	
			L (mm)	W (mm)	H (mm)	*1 Ripple current (Ar.m.s.)	*2 ESR (mΩ max.)		*4 240 °C	260 °C		
UD	4	120	7.3	4.3	2.8	3.0	15	EEFUD0G121ER	—	○	2000	
			7.3	4.3	2.8	3.4	12	EEFUD0G121XE	—	○	2000	
		150	7.3	4.3	2.8	3.0	15	EEFUD0G151ER	—	○	2000	
			7.3	4.3	2.8	3.3	12	EEFUD0G151XE	—	○	2000	
			7.3	4.3	2.8	3.4	9	EEFUD0G151LE	—	○	2000	
			7.3	4.3	2.8	3.4	9	EEFUD0G151LR	○	—	2000	
	180	7.3	4.3	2.8	2.5	18	EEFUD0G181ER	—	○	2000		
		7.3	4.3	2.8	3.4	9	EEFUD0G181LE	—	○	2000		
	6.3	100	7.3	4.3	2.8	3.0	15	EEFUD0J101ER	—	○	2000	
			7.3	4.3	2.8	3.3	12	EEFUD0J101XE	—	○	2000	
		120	7.3	4.3	2.8	3.0	15	EEFUD0J121ER	—	○	2000	
			7.3	4.3	2.8	3.3	12	EEFUD0J121XE	—	○	2000	
			7.3	4.3	2.8	3.4	9	EEFUD0J121LR	○	—	2000	
			7.3	4.3	2.8	3.4	9	EEFUD0J121LR	○	—	2000	
		150	7.3	4.3	2.8	2.5	18	EEFUD0J151ER	—	○	2000	
			7.3	4.3	2.8	3.4	9	EEFUD0J151LR	○	—	2000	
8	68	7.3	4.3	2.8	3.0	15	EEFUD0K680ER	—	○	2000		
	100	7.3	4.3	2.8	2.5	18	EEFUD0K101ER	—	○	2000		
UE	2	270	7.3	4.3	4.2	3.3	12	EEFUE0D271ER	—	○	2000	
			7.3	4.3	4.2	3.5	10	EEFUE0D271XE	—	○	2000	
		330	7.3	4.3	4.2	3.3	12	EEFUE0D331ER	—	○	2000	
			7.3	4.3	4.2	3.5	10	EEFUE0D331XE	—	○	2000	
		390	7.3	4.3	4.2	3.3	12	EEFUE0D391ER	—	○	2000	
			7.3	4.3	4.2	3.5	10	EEFUE0D391XE	—	○	2000	
			7.3	4.3	4.2	3.7	7	EEFUE0D391LE	—	○	2000	
			7.3	4.3	4.2	3.7	7	EEFUE0D391LR	○	—	2000	
		470	7.3	4.3	4.2	3.3	12	EEFUE0D471ER	—	○	2000	
			7.3	4.3	4.2	3.5	10	EEFUE0D471XE	—	○	2000	
		560	7.3	4.3	4.2	3.7	7	EEFUE0D561ER	—	○	2000	
			7.3	4.3	4.2	3.7	7	EEFUE0D561LE	—	○	2000	
	2.5	220	7.3	4.3	4.2	3.3	12	EEFUE0E221ER	—	○	2000	
			7.3	4.3	4.2	3.5	10	EEFUE0E221XE	—	○	2000	
		270	7.3	4.3	4.2	3.3	12	EEFUE0E271ER	—	○	2000	
			7.3	4.3	4.2	3.5	10	EEFUE0E271XE	—	○	2000	
		330	7.3	4.3	4.2	3.3	12	EEFUE0E331ER	—	○	2000	
			7.3	4.3	4.2	3.5	10	EEFUE0E331XE	—	○	2000	
			7.3	4.3	4.2	3.7	7	EEFUE0E331LE	—	○	2000	
			7.3	4.3	4.2	3.7	7	EEFUE0E331LR	○	—	2000	
		390	7.3	4.3	4.2	3.3	12	EEFUE0E391ER	—	○	2000	
			7.3	4.3	4.2	3.7	7	EEFUE0E391LE	—	○	2000	
		470	7.3	4.3	4.2	3.3	12	EEFUE0E471ER	—	○	2000	
			7.3	4.3	4.2	3.7	7	EEFUE0E471LE	—	○	2000	
	4	180	7.3	4.3	4.2	3.3	12	EEFUE0G181ER	—	○	2000	
			7.3	4.3	4.2	3.5	10	EEFUE0G181XE	—	○	2000	
		220	7.3	4.3	4.2	3.3	12	EEFUE0G221ER	—	○	2000	
			7.3	4.3	4.2	3.5	10	EEFUE0G221XE	—	○	2000	
			7.3	4.3	4.2	3.7	7	EEFUE0G221LE	—	○	2000	
			7.3	4.3	4.2	3.7	7	EEFUE0G221LR	○	—	2000	
		270	7.3	4.3	4.2	3.3	12	EEFUE0G271ER	—	○	2000	
			7.3	4.3	4.2	3.7	7	EEFUE0G271LE	—	○	2000	
		330	7.3	4.3	4.2	3.3	12	EEFUE0G331ER	—	○	2000	
			7.3	4.3	4.2	3.3	12	EEFUE0G331ER	—	○	2000	
		6.3	150	7.3	4.3	4.2	3.3	12	EEFUE0J151ER	—	○	2000
				7.3	4.3	4.2	3.5	10	EEFUE0J151XE	—	○	2000
	180		7.3	4.3	4.2	3.3	12	EEFUE0J181ER	—	○	2000	
			7.3	4.3	4.2	3.5	10	EEFUE0J181XE	—	○	2000	
			7.3	4.3	4.2	3.7	7	EEFUE0J181LR	○	—	2000	
			7.3	4.3	4.2	3.7	7	EEFUE0J181LR	○	—	2000	
	220		7.3	4.3	4.2	3.0	15	EEFUE0J221ER	—	○	2000	
			7.3	4.3	4.2	3.7	7	EEFUE0J221LR	○	—	2000	
	8	100	7.3	4.3	4.2	3.3	12	EEFUE0K101ER	—	○	2000	
		150	7.3	4.3	4.2	3.0	15	EEFUE0K151ER	—	○	2000	

*1: Ripple current (100 kHz/ +20 to +105 °C), *2: ESR (100 kHz/+20 °C)

*3: Please refer to the page of "Mounting Specifications".

*4: Please contact Panasonic for details of allowable 240 °C reflow condition.

Surface Mount Type

SP-Cap

Series: **SL**

Old series



■ Features

- Low-ESR (9 mΩ)
- Excellent Noise-absorbent Characteristics
- High Ripple Current
- RoHS directive compliant

[Our Requests]

Since this series is old, we don't recommend you to adopt it but SX series for your new design.

■ Specifications

Series & Size Code	SL			
Category Temp. Range	-40 °C to +105 °C			
Rated Voltage Range	2 V.DC to 6.3 V.DC			
Nominal Cap. Range	56 μF to 220 μF			
Capacitance Tolerance	±20 %			
DC Leakage Current	Reflow 240 °C : I ≤ 0.04 CV (μA) 2 minutes (6.3 V.DC) Reflow 260 °C : I ≤ 0.1 CV (μA) 2 minutes			
tan δ	≤ 0.06 (120 Hz/+20 °C)			
Surge Voltage	Rated Voltage × 1.25 (15 °C to 35 °C)			
Endurance	After applying rated voltage for 1000 hours at 105 °C±2 °C, and then being stabilized at +20 °C, capacitor shall meet the following limits.			
	Capacitance change	±10% of initial measured value		
	tan δ	≤ Initial specified value		
	DC leakage current	≤ Initial specified value		
Moisture resistance	After storing for 500 hours at 60 °C, 90 %			
	Capacitance change of initial measured value	2, 2.5 V.DC	4 V.DC	6.3 V.DC
		+70, -20 %	+60, -20 %	+50, -20 %
	tan δ	≤ 200 % of initial specified value		
	DC leakage current	≤ Initial specified value		

■ Marking

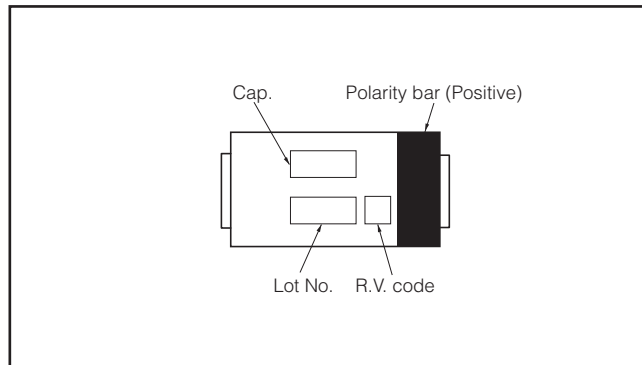

■ Dimensions in mm(not to scale)

(Unit : mm)

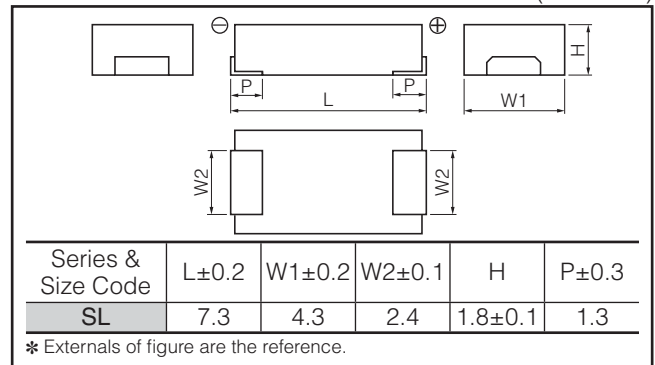

■ Low ESR Products

Series & Size Code	Rated Voltage (V.DC)	Capacitance (±20 %) (μF)	Case Size			Specification		Part number	Reflow ^{*3}		Min. Packaging Q'ty (pcs)
			L (mm)	W (mm)	H (mm)	Ripple current ^{*1} (Ar.m.s.)	ESR ^{*2} (mΩ max.)		240 °C ^{*4}	260 °C	
SL	2	100	7.3	4.3	1.8	3.0	9	EEFSL0D101ER	—	○	3500
		120	7.3	4.3	1.8	3.0	9	EEFSL0D121ER	—	○	3500
		150	7.3	4.3	1.8	3.0	9	EEFSL0D151ER	—	○	3500
		180	7.3	4.3	1.8	3.0	9	EEFSL0D181ER	—	○	3500
		220	7.3	4.3	1.8	3.0	9	EEFSL0D221ER	—	○	3500
	2.5	100	7.3	4.3	1.8	3.0	9	EEFSL0E101ER	—	○	3500
		120	7.3	4.3	1.8	3.0	9	EEFSL0E121ER	—	○	3500
		150	7.3	4.3	1.8	3.0	9	EEFSL0E151ER	—	○	3500
	4	82	7.3	4.3	1.8	3.0	9	EEFSL0G820ER	—	○	3500
	6.3	56	7.3	4.3	1.8	3.0	9	EEFSL0J560R	○	—	3500

*1: Ripple current (100 kHz/ +20 to +105 °C), *2: ESR (100 kHz/+20 °C)

*3: Please refer to the page of "Mounting Specifications".

*4: Please contact Panasonic for details of allowable 240 °C reflow condition.

Design and specifications are each subject to change without notice. Ask factory for the current technical specifications before purchase and/or use. Should a safety concern arise regarding this product, please be sure to contact us immediately.

Surface Mount Type

SP-Cap

Series: **MC**

Old series



■ Features

- Achieved 40 % miniaturization on together with low ESR of SP-Cap for further design flexibility.
- RoHS directive compliant

[Our Requests]

Since this series is old, we don't recommend you to adopt it

■ Specifications

Category Temp. Range	-40 °C to +105 °C			
Rated Voltage Range	2 V.DC to 6.3 V.DC			
Nominal Cap.Range	47 μF to 120 μF			
Capacitance Tolerance	±20 % (120 Hz/+20 °C)			
DC Leakage Current	I ≤ 0.1 CV (μA) 2 minutes			
tan δ	≤ 0.06 (120 Hz/+20 °C)			
Surge Voltage	Rated Voltage × 1.25 (15 °C to 35 °C)			
Endurance	After applying rated voltage for 1000 hours at 105 °C±2 °C and then being atabilized at +20 °C, Capacitor shall			
	Capacitance change	±10% of initial measured value		
	tan δ	≤ Initial specified value		
	DC leakage current	≤ Initial specified value		
Moisture resistance	After storing for 500 hours at 60 °C, 90 %			
	Capacitance change of initial measurd value	2, 2.5 V.DC	4 V.DC	6.3 V.DC
		+70, -20 %	+60, -20 %	+50, -20 %
	tan δ	≤ 200 % of initial specified value		
	DC leakage current	≤ Initial specified value		

■ Marking

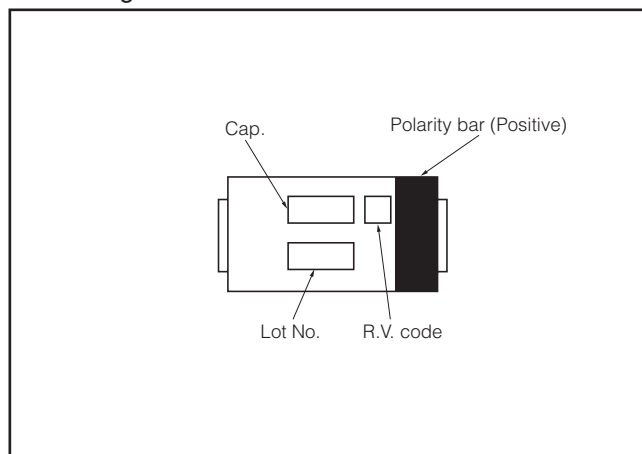

■ Dimensions in mm(not to scale)

(Unit : mm)

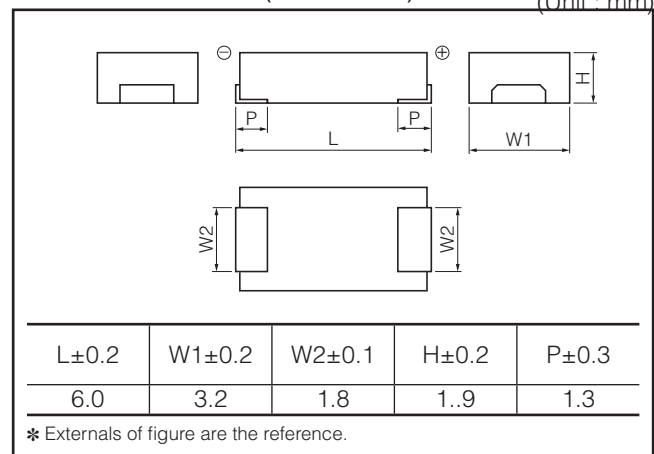

■ Standard Products

Reflow *3

<260 °C>

Series & Size Code	Rated Voltage (V.DC)	Capacitance (±20 %) (μF)	Case Size			Specification		Part number	Min. Packaging Q'ty (pcs)
			L (mm)	W (mm)	H (mm)	Ripple current *1 (Ar.m.s.)	ESR *2 (mΩ max.)		
MC	2	120	6.0	3.2	1.9	2.7	12	EEFMC0D121R	3000
	2.5	100	6.0	3.2	1.9	2.7	12	EEFMC0E101R	3000
	4	82	6.0	3.2	1.9	2.2	18	EEFMC0G820R	3000
	6.3	47	6.0	3.2	1.9	2.2	18	EEFMC0J470R	3000

*1: Ripple current (100 kHz/ +20 to +105 °C), *2: ESR (100 kHz/+20 °C)

*3: Please refer to the page of "Mounting Specifications".

Design and specifications are each subject to change without notice. Ask factory for the current technical specifications before purchase and/or use. Should a safety concern arise regarding this product, please be sure to contact us immediately.

02 Mar. 2015

CAUTION AND WARNING

1. The electronic components contained in this catalog are designed and produced for use in home electric appliances, office equipment, information equipment, communications equipment, and other general purpose electronic devices.
Before use of any of these components for equipment that requires a high degree of safety, such as medical instruments, aerospace equipment, disaster-prevention equipment, security equipment, vehicles (automobile, train, vessel), please be sure to contact our sales representative.
2. When applying one of these components for equipment requiring a high degree of safety, no matter what sort of application it might be, be sure to install a protective circuit or redundancy arrangement to enhance the safety of your equipment. In addition, please carry out the safety test on your own responsibility.
3. When using our products, no matter what sort of equipment they might be used for, be sure to make a written agreement on the specifications with us in advance.
4. Technical information contained in this catalog is intended to convey examples of typical performances and/or applications and is not intended to make any warranty with respect to the intellectual property rights or any other related rights of our company or any third parties nor grant any license under such rights.
5. In order to export products in this catalog, the exporter may be subject to the export license requirement under the Foreign Exchange and Foreign Trade Law of Japan.
6. No ozone-depleting substances (ODSs) under the Montreal Protocol are used in the manufacturing processes of Automotive & Industrial Systems Company, Panasonic Corporation.

● Please contact

● Factory

Device Solutions Business Division
Automotive & Industrial Systems Company
Panasonic Corporation
1006 Kadoma, Kadoma City, Osaka 571-8506,
JAPAN

The information in this catalog is valid as of December 2015.