

REV.	DATE	DESCRIPTION
NC	02/02/05	INITIAL RELEASE

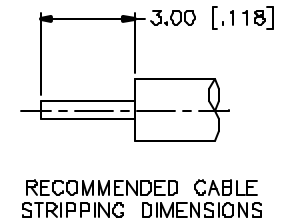
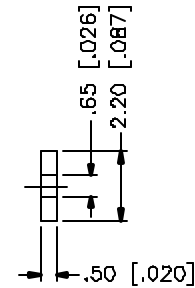
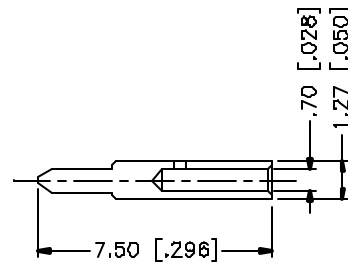
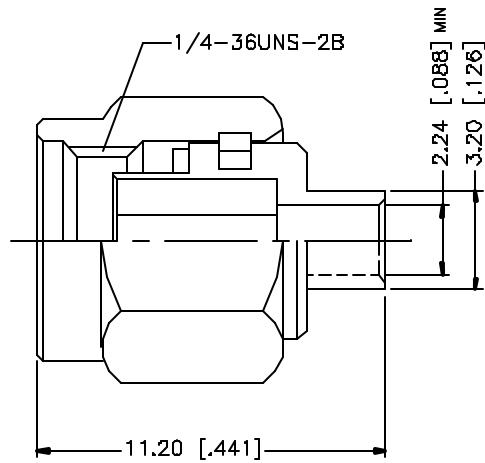

8				
7				
6				
5				
4				
3	CONTACT PIN	BRASS	GOLD	1
2	INSULATOR	TEFLON	NATURAL	1
1	BODY	BRASS	GOLD	1
DESCRIPTION	MATERIAL	FINISH	QTY	

UNLESS OTHERWISE SPECIFIED DIMENSIONS ARE IN MILLIMETERS. DIMENSIONS IN [] ARE IN INCHES AND FOR CUSTOMER REFERENCE ONLY.

UNLESS OTHERWISE SPECIFIED TOLERANCES FOR MILLIMETERS ARE:
D.5 - 8mm ± 0.20mm
8 - 30mm ± 0.40mm
30 - 120mm ± 0.50mm

UNLESS OTHERWISE SPECIFIED TOLERANCES FOR INCHES ARE:
.020 - .315 = ± 0.007"
.315 - 1.180 = ± 0.010"
1.180 - 4.724 = ± 0.020"

DO NOT SCALE DRAWING

APPROVALS		DATE
DRAWN	G.R.S.	02/02/05
CHECKED		
ISSUED		
SHEET	1 OF 1	
CAD FILE		
C:/132/132101-10.DWG		

Amphenol Connex

PART DESCRIPTION
SMA SEMI-RIGID PLUG
(FOR MICRO COAX UT85-LL CABLE))

PART NO. **132101-10**

DWG. NO.	132101-10.DWG	REV.	NC	SIZE	A	SCALE	NA
----------	---------------	------	----	------	---	-------	----