

PULSE click

2. Soldering the headers

Before using your click board™, make sure to solder 1x8 male headers to both left and right side of the board. Two 1x8 male headers are included with the board in the package.

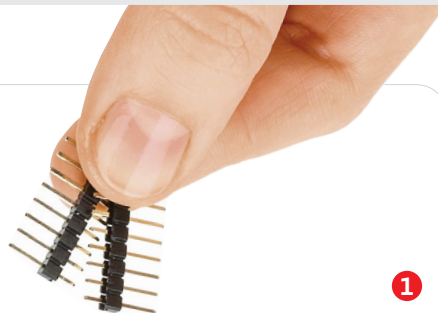

2

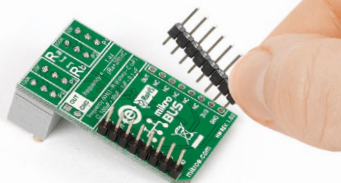

Turn the board upside down so that the bottom side is facing you upwards. Place shorter pins of the header into the appropriate soldering pads.

3

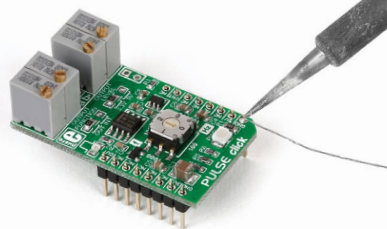

Turn the board upward again. Make sure to align the headers so that they are perpendicular to the board, then solder the pins carefully.

1. Introduction

PULSE click is a pulse generator with an adjustable frequency. It carries the **NEN555** precision timer capable of producing highly accurate time delays, and the output can be sent to the MCU through the OUT pin, (default mikroBUS™ AN pin) or an interrupt (INT pin) or an interrupt (INT pin). An extra output pin above the mikroBUS™ socket is also available. Designed to use either a 3.3V or a 5V power supply.

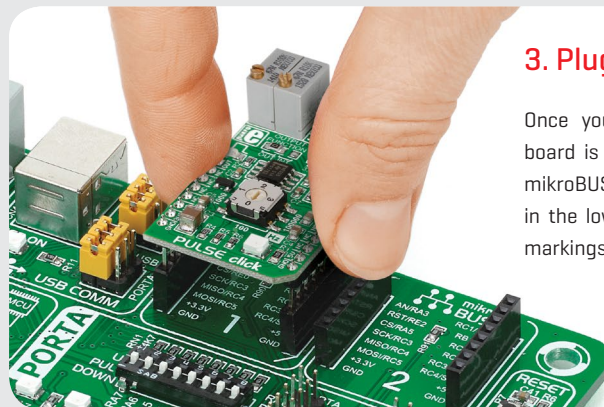

3. Plugging the board in

Once you have soldered the headers your board is ready to be placed into the desired mikroBUS™ socket. Make sure to align the cut in the lower-right part of the board with the markings on the silkscreen at the mikroBUS™ socket. If all the pins are aligned correctly, push the board all the way into the socket.

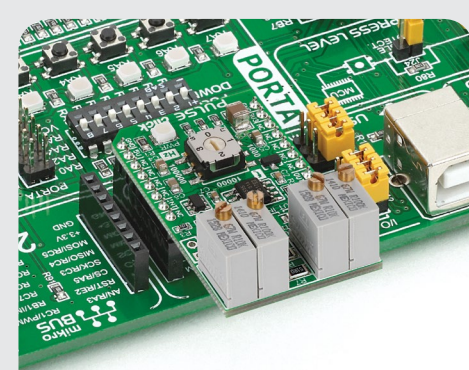

4. Essential features

The frequency of PULSE click is configured in two steps. First select between four frequency bands by using the frequency selector - a circular central switch in the middle of the board. Starting from the six-o'clock position and moving counter-clockwise in quarters, it has 4 options: 0] Up to 100 Hz; 1] Up to 1 kHz; 2] Up to 10 kHz; and 3] Up to 100 kHz. After you select the appropriate position, use the onboard potentiometer to fine-tune the desired output frequency.

click
BOARDS™
www.mikroe.com



PULSE click Manual v1.00



010000092453

5. Schematic

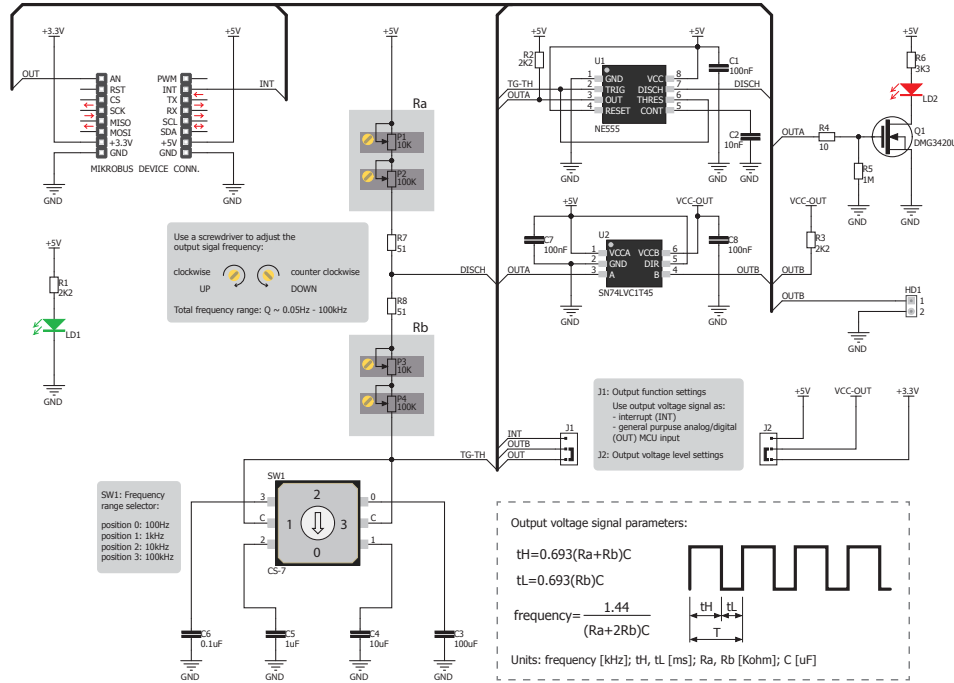

6. Dimensions

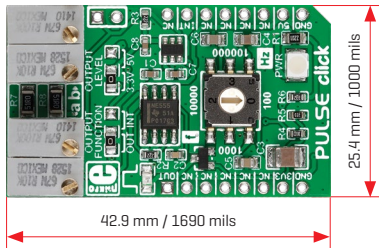

	mm	mils
LENGTH	42.9	1690
WIDTH	25.4	1000
HEIGHT*	3.9	154

* without headers

7. SMD jumper

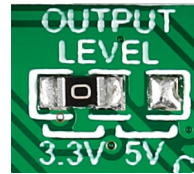

PULSE click features an SMD jumper [zero ohm resistor] that let's you switch between a 3.3V or a 5V power supply.

8. Code examples

Once you have done all the necessary preparations, it's time to get your click board™ up and running. We have provided examples for mikroC™, mikroBasic™ and mikroPascal™ compilers on our **Libstock** website. Just download them and you are ready to start.



9. Support

MikroElektronika offers **free tech support** [www.mikroe.com/support] until the end of the product's lifetime, so if something goes wrong, we're ready and willing to help!



10. Disclaimer

MikroElektronika assumes no responsibility or liability for any errors or inaccuracies that may appear in the present document. Specification and information contained in the present schematic are subject to change at any time without notice.

Copyright © 2015 MikroElektronika.
All rights reserved.