

THIS DRAWING IS UNPUBLISHED. RELEASED FOR PUBLICATION JULY, 2005.  
 © COPYRIGHT 2005 By - ALL RIGHTS RESERVED.

LOC		DIST		REVISIONS			
P	LTR	DESCRIPTION	DATE	DWN	APVD		
	B1	REVISED PER ECO-11-005033	31MAR11	RK	HMR		
	C	REVISED PER ECO-12-010787	11JUN12	TITAN	MARTIN		

NOTES

- 1. 100 TRAY PACK IN ACCORDANCE WITH AMP SPEC 107-3275
- 2. SINGLE PACK IN ACCORDANCE WITH AMP SPEC 107-3275
- 3. Au PLATING OVER Ni PLATING OVER Cu PLATING
- 4. Ni PLATING OVER Cu PLATING
- 5. HAND TOOL: 9-1478240-0
- 6. DIE SET: SEE TABLE
- 7. FOR TECHNICAL DATA REFER TO YOUR LOCAL TE CONNECTIVITY SALES OFFICE
- 8. ALL DIMENSIONS ARE NOMINAL FOR REFERENCE ONLY UNLESS OTHERWISE STATED

DIMENSIONS	CABLE GROUPS	PART NO.
6.50 5.45 3.80 0.85 6.60 7.52	9-1478242-0 RG59B/U, 62A/U, 140/U, 210/U, URM90, KX 6A, KX 25, KX 52, KX 53	5-1634516-5
6.50 5.45 3.80 0.85 6.60 7.52	9-1478242-0 RG59B/U, 62A/U, 140/U, 210/U, URM90, KX 6A, KX 25, KX 52, KX 53	5-1634516-4
5.60 4.60 3.20 0.40 - -	9-1478242-0 RG179B/U, 187A/U, URM111	5-1634516-3
5.60 4.60 3.20 0.40 - -	9-1478242-0 RG179B/U, 187A/U, URM111	5-1634516-2
5.60 - - 1.10 5.40 6.40	9-1478242-0 RG58C/U, 141A/U, URM43, 76, BELDEN 9907, KX 15	5-1634516-1
5.60 - - 1.10 5.40 6.40	9-1478242-0 RG58C/U, 141A/U, URM43, 76, BELDEN 9907, KX 15	5-1634516-0
F E D C B A	DIE SET	CABLE GROUPS

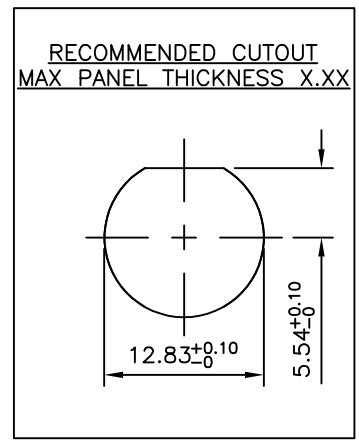
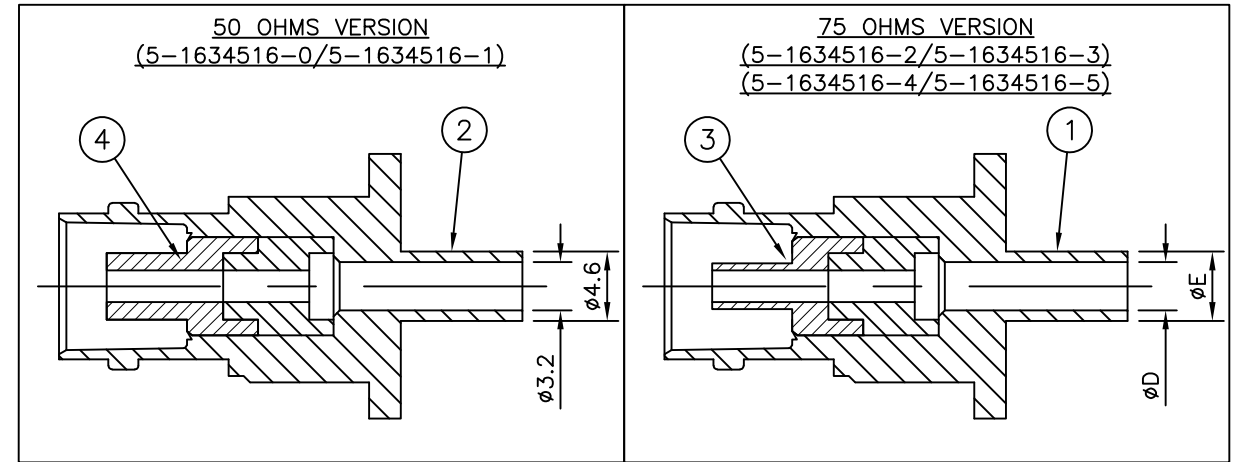
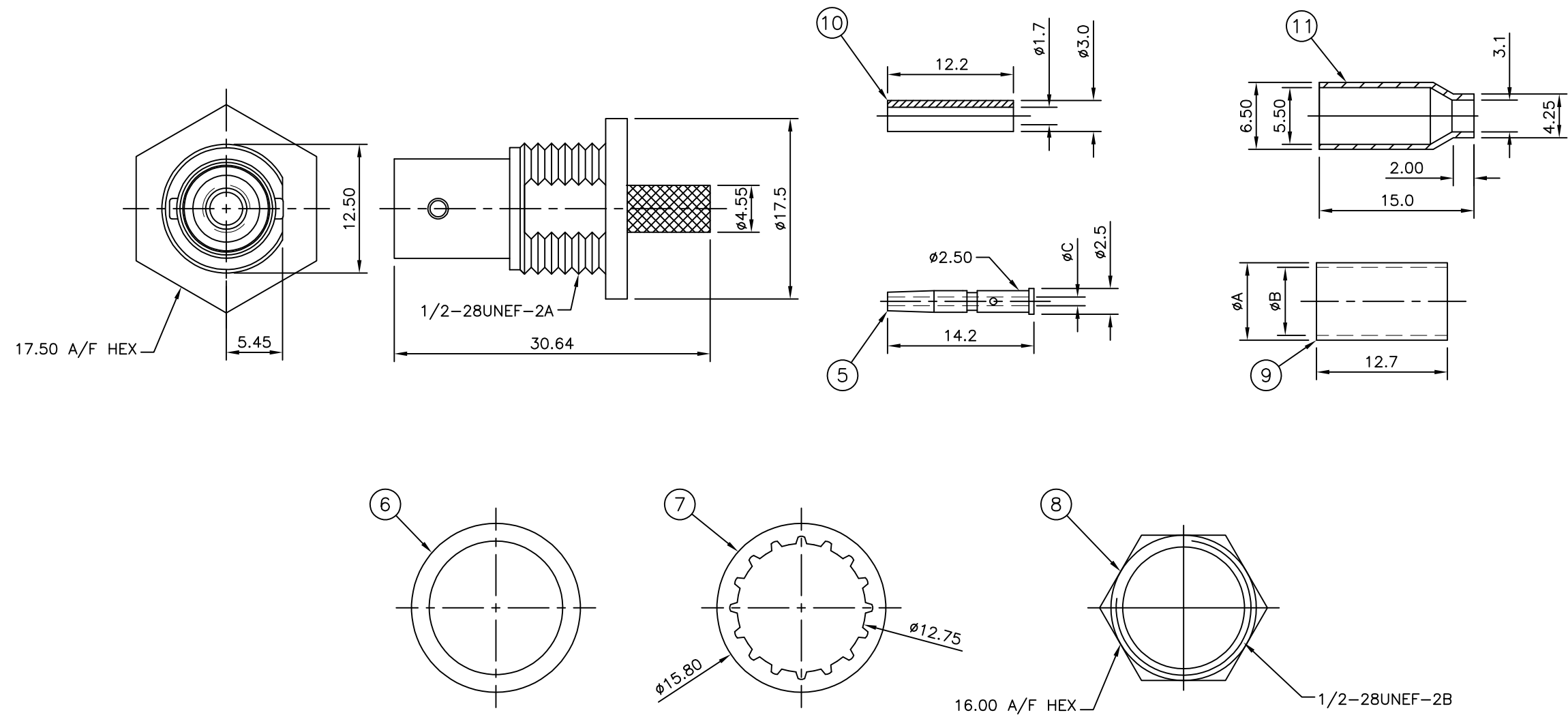

QTY	UNIT	DESCRIPTION	MATERIAL	ITEM				
-	-	1	1	-	BRASS	FERRULE	11	
-	-	1	1	-	NYLON	PUSHER SLEEVE	10	
1	1	-	-	1	1	BRASS	FERRULE	9
1	1	1	1	1	1	BRASS	HEX NUT	8
1	1	1	1	1	1	PHOS BRONZE	LOCK WASHER	7
1	1	1	1	1	1	RUBBER	GASKET	6
1	1	1	1	1	1	BRASS	CONTACT	5
-	-	-	-	1	1	POLYMETHYLPENTENE	INSULATOR	4
1	1	1	1	-	-	POLYMETHYLPENTENE	INSULATOR	3
-	-	-	-	1	1	ZINC ALLOY	BODY	2
1	1	1	1	-	-	ZINC ALLOY	BODY	1
5--5	5--4	5--3	5--2	5--1	5--0	MATERIAL	DESCRIPTION	ITEM

THIS DRAWING IS A CONTROLLED DOCUMENT.

DWN: RITA ZUO 24 Feb 09  
 CHK: ANSON MA 24 Feb 09  
 APVD: BOB ZHAO 24 Feb 09

TE Connectivity  
 BNC BULKHEAD JACK REAR MOUNT CRIMP

108-112000  
 SEE SHEET 2

SCALE: A2 00779 C=1634516  
 SHEET: 1 of 2  
 REV: C

THIS DRAWING IS UNPUBLISHED. RELEASED FOR PUBLICATION JULY, 2005.  
 © COPYRIGHT 2005 By - ALL RIGHTS RESERVED.

LOC	DIST	REVISIONS					
		P	LTR	DESCRIPTION	DATE	DWN	APVD
E	B	-	-	SEE SHEET 1	-	-	-

COMPONENTS

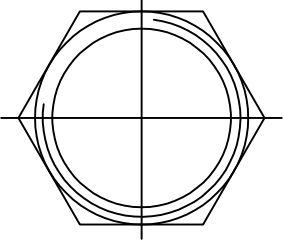
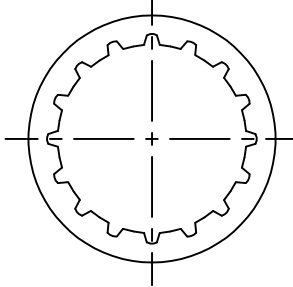
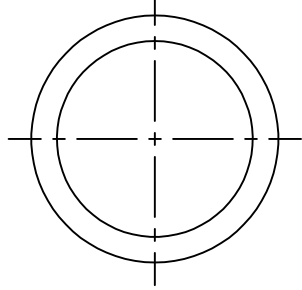
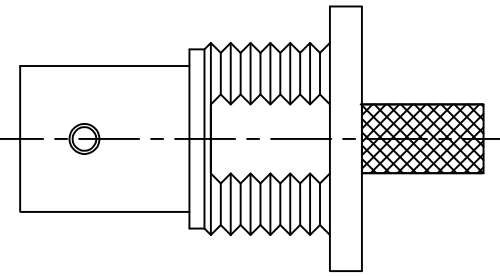
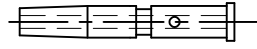
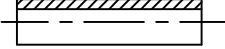
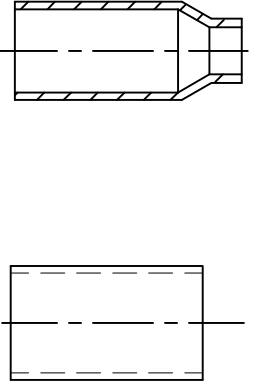
HEX NUT (ITEM 8)	LOCK WASHER (ITEM 7)	GASKET (ITEM 6)	MAIN BODY (ITEM 1,2,3, & 4)	CENTRE CONTACT (ITEM 5)	PUSHER SLEEVE (ITEM 10)	CRIMP FERRULES (ITEM 9 & 11)
						

ASSEMBLY INSTRUCTION

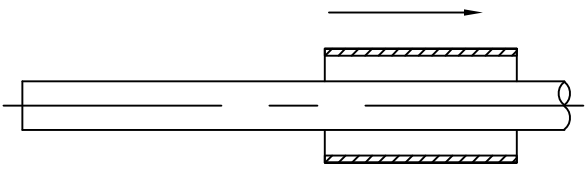
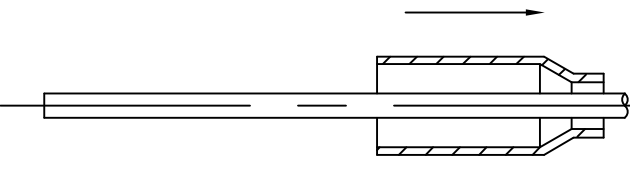
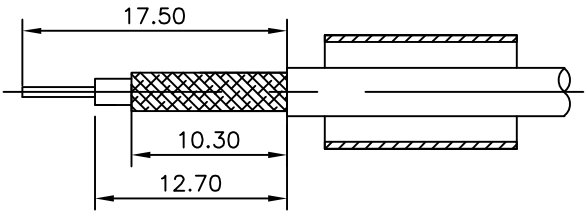
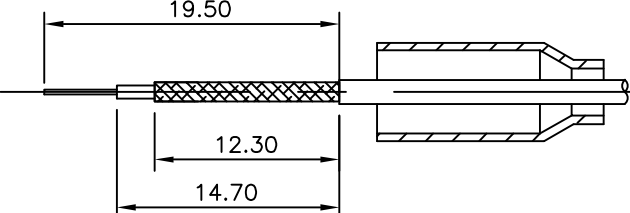
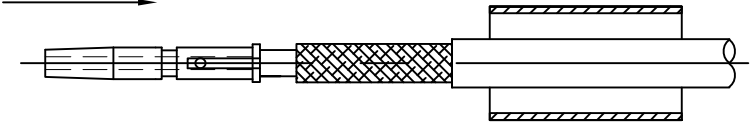
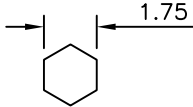
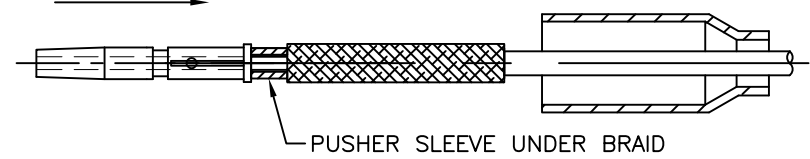
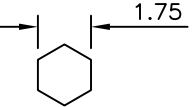
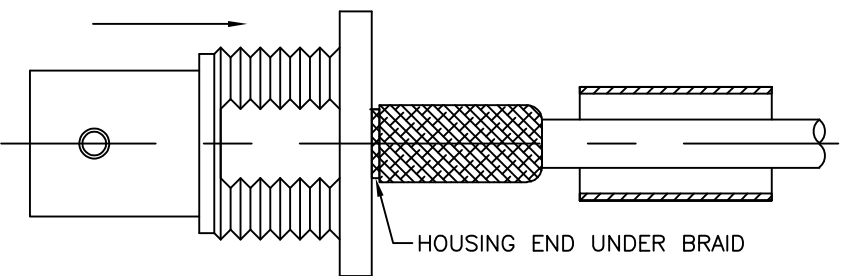
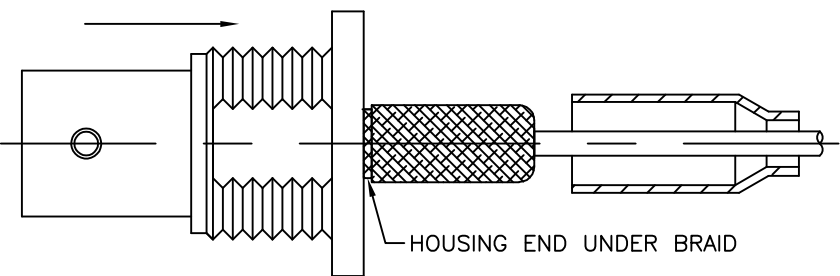
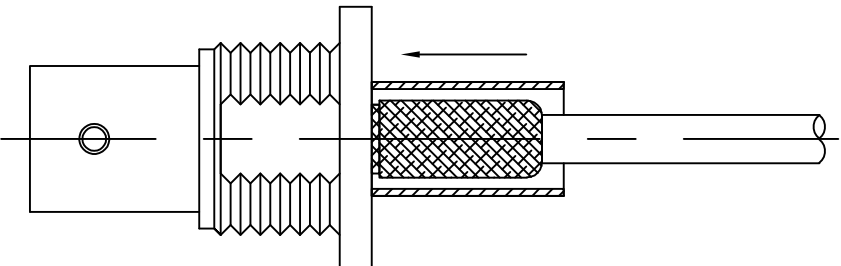
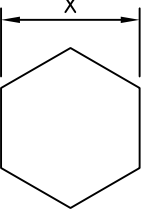
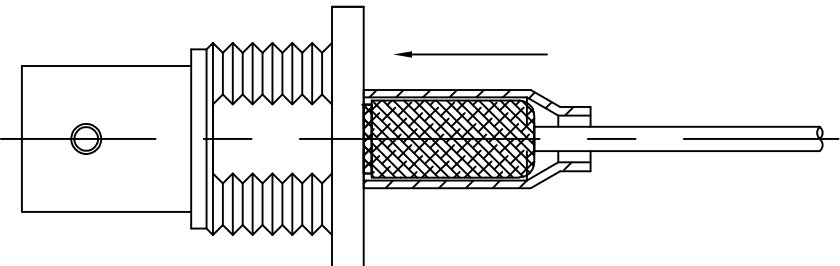
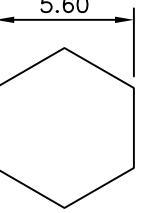
CABLES: RG59B/U, 62A/U, 140/U, 210/U, URM90, KX 6A, KX 25, KX 52, KX 53, RG58C/U, 141A/U, URM43, 76, BELDEN 9907, KX 15	CABLES: RG179B/U, 187A/U, URM111
<p><b>STEP 1</b></p> <p>1. SLIDE METAL CRIMP FERRULE OVER CABLE</p> 	<p><b>STEP 1</b></p> <p>1. SLIDE METAL CRIMP FERRULE OVER CABLE</p> 
<p><b>STEP 2</b></p> <p>1. STRIP CABLE TO DIMENSIONS AS SHOWN</p> 	<p><b>STEP 2</b></p> <p>1. STRIP CABLE TO DIMENSIONS AS SHOWN</p> 
<p><b>STEP 3</b></p> <p>1. FIT CONTACT OVER CENTRE CONDUCTOR TO BUTT AGAINST DIELECTRIC.            2. CRIMP USING TOOL AS NOTES ON PAGE 1.</p>  <p>RECOMMENDED CENTRE CONTACT A/F HEX</p> 	<p><b>STEP 3</b></p> <p>1. SLIDE ITEM 10 PUSHER SLEEVE OVER DIELECTRIC BEFORE FITTING THE CONTACT.            2. FIT CONTACT OVER CENTRE CONDUCTOR TO BUTT AGAINST DIELECTRIC.            3. CRIMP USING TOOL AS NOTES ON PAGE 1.</p>  <p>PUSHER SLEEVE UNDER BRAID</p> <p>RECOMMENDED CENTRE CONTACT A/F HEX</p> 
<p><b>STEP 4</b></p> <p>1. PRESS SUB-ASSEMBLY INTO BODY, UNTIL CONTACT IS FULLY LOCATED BY AN AUDIBLE CLICK.            2. ENSURE THAT KNURLED HOUSING INSERTS BETWEEN THE DIELECTRIC AND CABLE BRAID.</p>  <p>HOUSING END UNDER BRAID</p>	<p><b>STEP 4</b></p> <p>1. PRESS SUB-ASSEMBLY INTO BODY, UNTIL CONTACT IS FULLY LOCATED BY AN AUDIBLE CLICK.            2. ENSURE THAT KNURLED HOUSING INSERTS BETWEEN THE PUSHER SLEEVE AND CABLE BRAID.</p>  <p>HOUSING END UNDER BRAID</p>
<p><b>STEP 5</b></p> <p>1. SLIDE CRIMP FERRULE ALONG THE CABLE UNTIL IT BUTTS AGAINST THE HOUSING BODY.            2. CRIMP USING TOOL AS NOTED ON PAGE 1.            3. CRIMP DIMENSION X IS:-            RG59B (SEE PAGE 1 FOR FULL CABLE LIST) = 6.50            RG58C/U (SEE PAGE 1 FOR FULL CABLE LIST) = 5.60</p>  <p>RECOMMENDED CRIMP SLEEVE A/F HEX</p> 	<p><b>STEP 5</b></p> <p>1. SLIDE CRIMP FERRULE ALONG THE CABLE UNTIL IT BUTTS AGAINST THE BODY HOUSING.            2. CRIMP USING TOOL AS NOTED ON PAGE 1.            3. CRIMP DIMENSION AS SHOWN.</p>  <p>RECOMMENDED CRIMP SLEEVE A/F HEX</p> 

THIS DRAWING IS A CONTROLLED DOCUMENT.

DWN	RITA ZUO	24 Feb 09
CHK	ANSON MA	24 Feb 09
APVD	BOB ZHAO	24 Feb 09
PRODUCT SPEC	108-112000	
APPLICATION SPEC	SHEET 2	
WEIGHT	-	
CUSTOMER DRAWING		

TE Connectivity

BNC BULKHEAD JACK REAR MOUNT CRIMP

SIZE: A2 CAGE CODE: 00779 DRAWING NO: C=1634516 RESTRICTED TO: -

SCALE: NTS SHEET: 2 of 2 REV: B1