

NOTES

MATERIAL-ALUMINUM DIE-CAST: G AI SI 12 / DIN 1775
 LID SCREWS-CAPTIVE STAINLESS STEEL
 EMI/RFI GASKET IS NOT REQUIRED AS LID TO BOX CONNECTION IS INSIDE THE GASKET SEAL.
 DEGREE OF PROTECTION NEMA 4X, IP66
 NEOPRENE OIL AND PETROL RESISTANT-THERMOPLASTIC GASKET (-40 C TO +120 C)
 TEXTURED POLYESTER POWDER COAT, GREY RAL 7032

LID

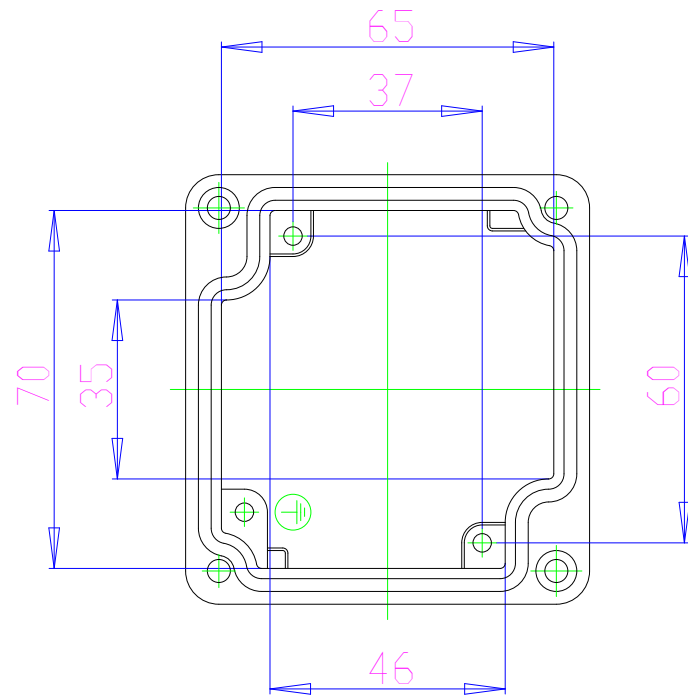

BOTTOM

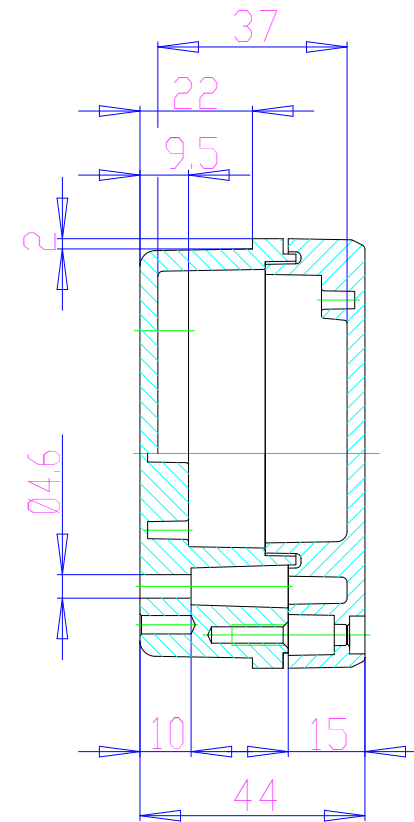
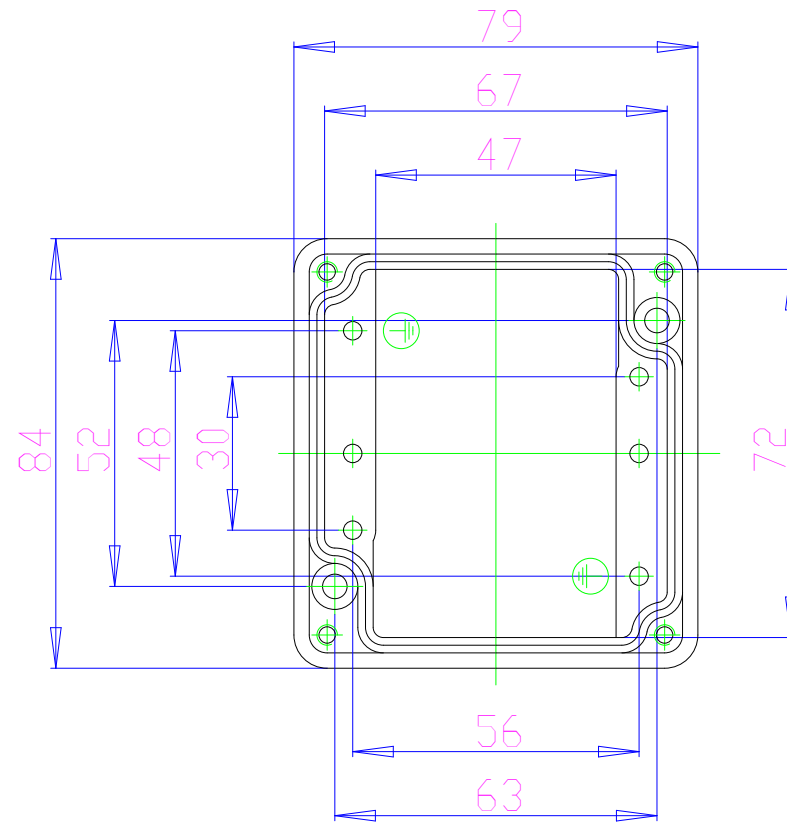

For the best fit print on legal size paper.

THIS DRAWING IS PROPRIETARY INFORMATION OF HAMMOND MFG.CO.LTD. NOT TO BE USED WITHOUT EXPRESSED WRITTEN PERMISSION OF HAMMOND MFG.CO.LTD.

△	N/A	RELEASE	----	03 01 03	MJM
Rev	ECN	Description		Date	B

Dwn	M. MERCER
Date	03 01 03
Chk	---
Mat'l	DIE-CAST ALUMINUM
Sheet	1 of 1

HAMMOND MANUFACTURING CO. LTD. Electronics Group, Waterloo, Ont. - Cheektowaga, NY	ROLEC conFORM SERIES ENCLOSURES	
	Part#: R111-081-000	Dwg: EKF 081

