

# IMD10AMT1G

## Dual Bias Resistor Transistor

### NPN and PNP Silicon Surface Mount Transistors with Monolithic Bias Resistor Network

- High Current:  $I_C = 500$  mA max
- This is a Pb-Free Device

#### MAXIMUM RATINGS ( $T_A = 25^\circ\text{C}$ )

Rating	Symbol	Value	Unit
Collector-Base Voltage	$V_{(BR)CBO}$	50	Vdc
Collector-Emitter Voltage	$V_{(BR)CEO}$	50	Vdc
Emitter-Base Voltage	$V_{(BR)EBO}$	5.0	Vdc
Collector Current - Continuous	$I_C$	500	mAdc

#### THERMAL CHARACTERISTICS

Characteristic	Symbol	Max	Unit
Power Dissipation*	$P_D$	285	mW
Junction Temperature	$T_J$	150	$^\circ\text{C}$
Storage Temperature	$T_{stg}$	-55 to +150	$^\circ\text{C}$

Stresses exceeding those listed in the Maximum Ratings table may damage the device. If any of these limits are exceeded, device functionality should not be assumed, damage may occur and reliability may be affected.

\*Total for both Transistors.



**ON Semiconductor**<sup>®</sup>

<http://onsemi.com>

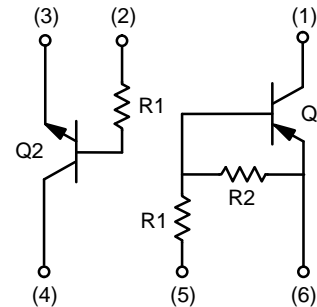

SC-74

#### MARKING DIAGRAM



SC-74R  
318AA  
Style 21

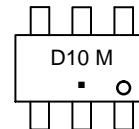

D10 = Specific Device Code  
M = Date Code  
■ = Pb-Free Package

#### ORDERING INFORMATION

Device	Package	Shipping <sup>†</sup>
IMD10AMT1G	SC-74R (Pb-Free)	3000 / Tape & Reel

<sup>†</sup>For information on tape and reel specifications, including part orientation and tape sizes, please refer to our Tape and Reel Packaging Specifications Brochure, BRD8011/D.

# IMD10AMT1G

## ELECTRICAL CHARACTERISTICS

( $T_A = 25^\circ\text{C}$  unless otherwise noted, common for Q<sub>1</sub> and Q<sub>2</sub>, – minus sign for Q<sub>1</sub>(PNP) omitted)

Characteristic	Symbol	Min	Max	Unit
<b>OFF CHARACTERISTICS</b>				
Collector–Base Breakdown Voltage ( $I_C = 50\ \mu\text{Adc}$ , $I_E = 0\ \text{A}$ )	$V_{(BR)CBO}$	50	–	Vdc
Collector–Emitter Breakdown Voltage ( $I_C = 1.0\ \text{mAdc}$ , $I_B = 0\ \text{A}$ )	$V_{(BR)CEO}$	50	–	Vdc
Emitter–Base Breakdown Voltage ( $I_E = 50\ \mu\text{Adc}$ , $I_C = 0\ \text{A}$ )	$V_{(BR)EBO}$	5.0	–	Vdc
Collector–Base Cutoff Current ( $V_{CB} = 50\ \text{Vdc}$ , $I_E = 0\ \text{A}$ )	$I_{CBO}$	–	100	nA
Emitter–Base Cutoff Current ( $V_{EB} = 6.0\ \text{Vdc}$ , $I_C = 0\ \text{A}$ )	$I_{EBO}$	–	1.0 0.5	mA
Collector–Emitter Cutoff Current ( $V_{CE} = 15\ \text{Vdc}$ , $I_B = 0\ \text{A}$ )	$I_{CEO}$	–	500	nA
Collector–Emitter Cutoff Current ( $V_{CE} = 25\ \text{Vdc}$ , $I_B = 0\ \text{A}$ )	$I_{CES}$	–	100	nA

## ON CHARACTERISTICS (Note 1)

DC Current Gain ( $V_{CE} = 5.0\ \text{V}$ , $I_C = 100\ \text{mA}$ ) Q1(PNP) ( $V_{CE} = 5.0\ \text{V}$ , $I_C = 1.0\ \text{mA}$ ) Q2(NPN)	$h_{FE}$	68 100	– 600	
Collector–Emitter Saturation Voltage ( $I_C = 10\ \text{mA}$ , $I_B = 1.0\ \text{mA}$ )	$V_{CE(sat)}$	–	0.3	Vdc
Output Voltage (on) ( $V_{CC} = 5.0\ \text{V}$ , $V_B = 2.5\ \text{V}$ , $R_L = 1.0\ \text{k}\Omega$ )	$V_{OL}$	–	0.2	Vdc
Output Voltage (off) ( $V_{CC} = 5.0\ \text{V}$ , $V_B = 0.25\ \text{V}$ , $R_L = 1.0\ \text{k}\Omega$ )	$V_{OL}$	4.9	–	Vdc
Input Resistor Q1(PNP) Q2(NPN)	R1	70 7.0	130 13	$\Omega$ k $\Omega$
Resistor Ratio Q1(PNP) Q2(NPN)	R1/R2	0.008 –	0.012 –	

1. Pulse Test: Pulse Width  $\leq 300\ \mu\text{s}$ , Duty Cycle  $< 2.0\%$ .

# IMD10AMT1G

## TYPICAL CHARACTERISTICS (NPN)

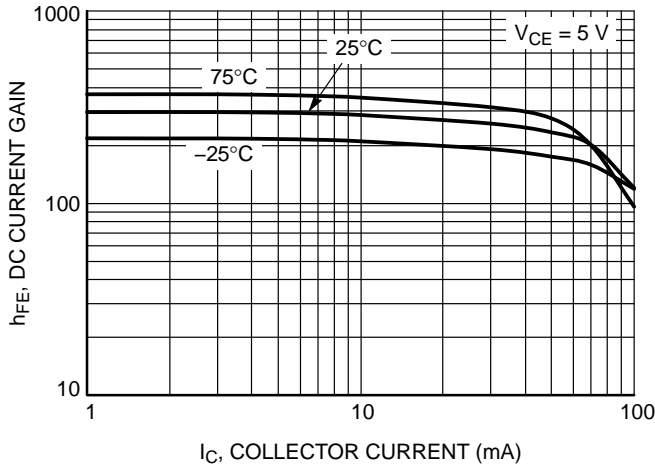

Figure 1. DC Current Gain

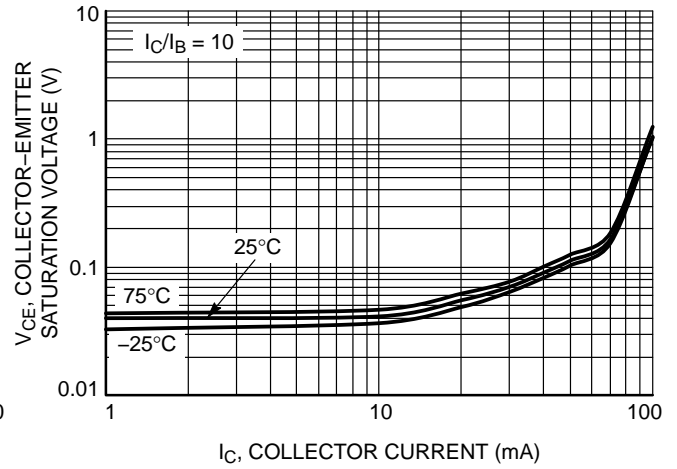

Figure 2. Collector-Emitter Saturation Voltage

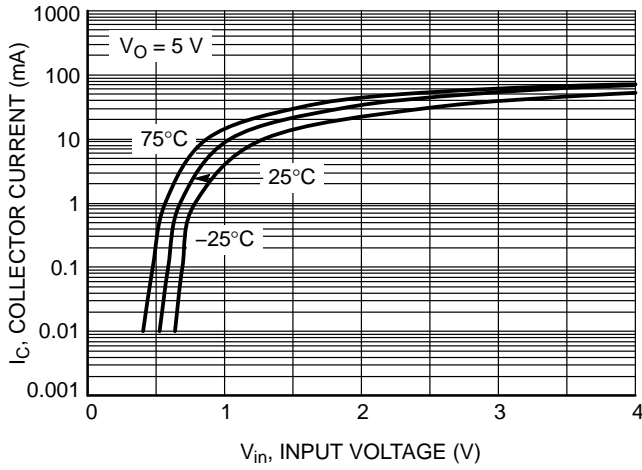

Figure 3. Output Current vs. Input Voltage

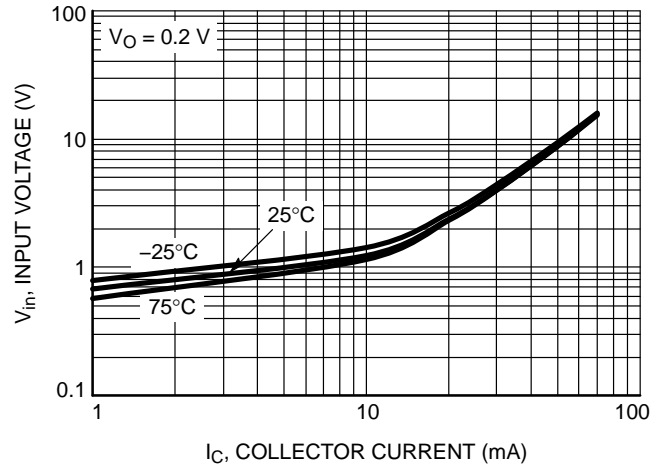

Figure 4. Input Voltage vs. Output Current

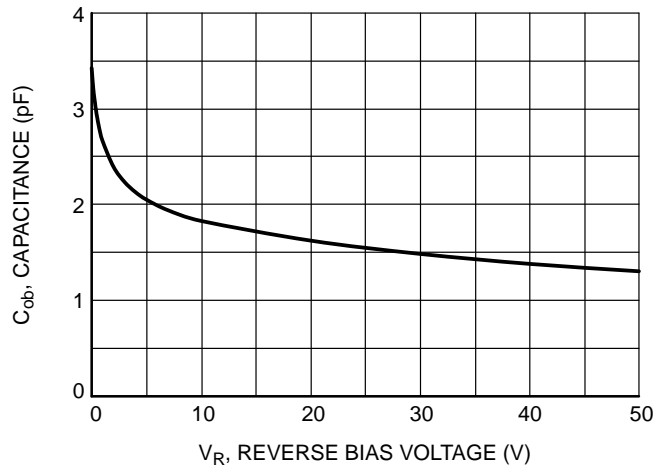

Figure 5. Output Capacitance

# IMD10AMT1G

## TYPICAL CHARACTERISTICS (PNP)

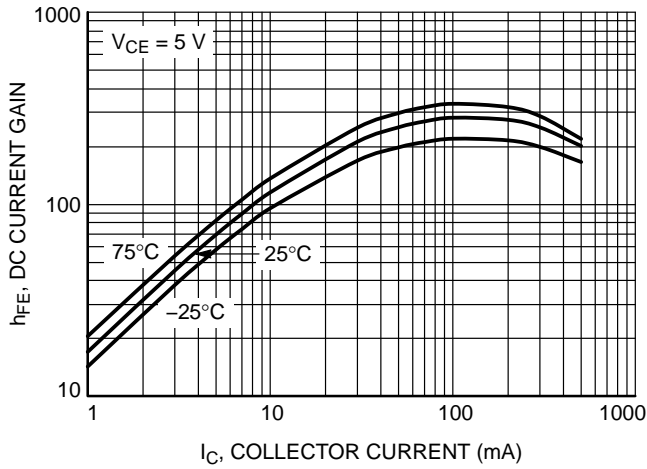

Figure 6. DC Current Gain

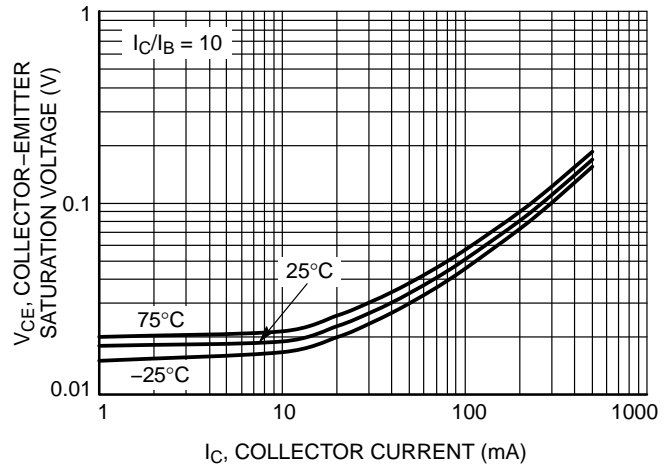

Figure 7. Collector-Emitter Saturation Voltage

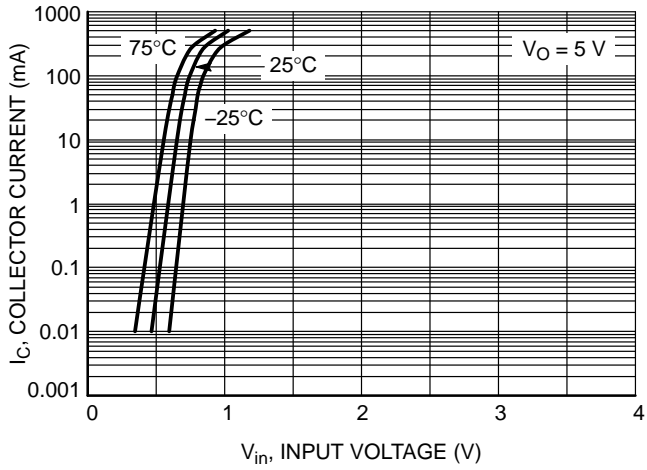

Figure 8. Output Current vs. Input Voltage

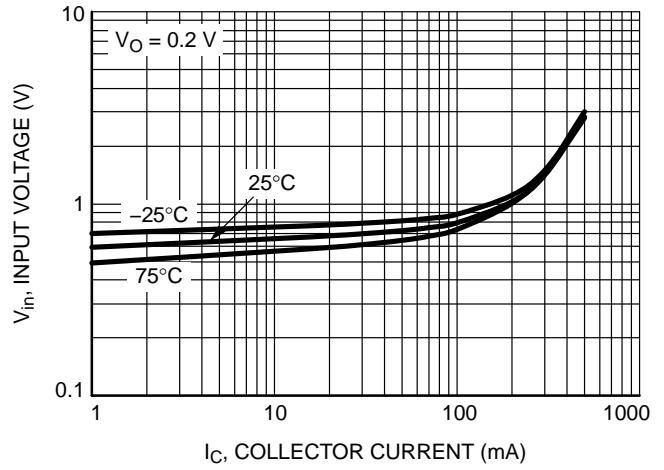

Figure 9. Input Voltage vs. Output Current

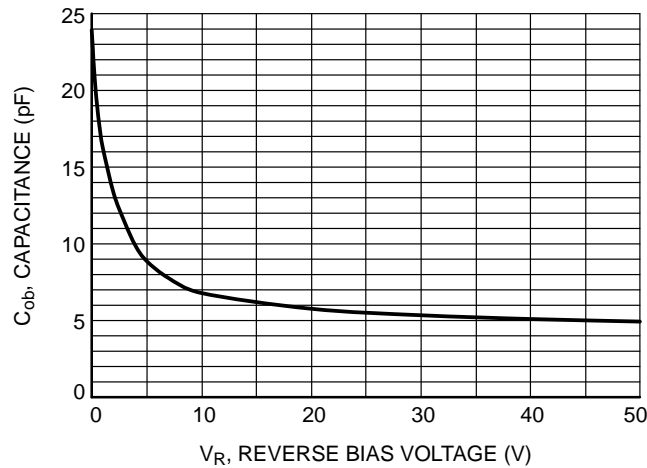
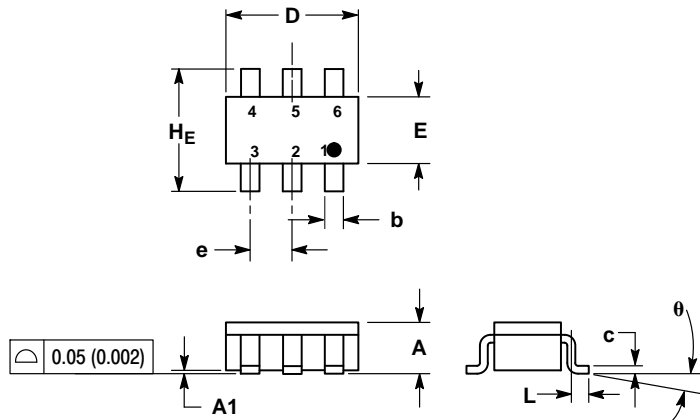

Figure 10. Output Capacitance

# IMD10AMT1G

## PACKAGE DIMENSIONS

### SC-74R CASE 318AA ISSUE B



#### NOTES:

1. DIMENSIONING AND TOLERANCING PER ANSI Y14.5M, 1982.
2. CONTROLLING DIMENSION: INCH.
3. MAXIMUM LEAD THICKNESS INCLUDES LEAD FINISH THICKNESS. MINIMUM LEAD THICKNESS IS THE MINIMUM THICKNESS OF BASE MATERIAL.

DIM	MILLIMETERS			INCHES		
	MIN	NOM	MAX	MIN	NOM	MAX
A	0.90	1.00	1.10	0.035	0.039	0.043
A1	0.01	0.06	0.10	0.001	0.002	0.004
b	0.25	0.37	0.50	0.010	0.015	0.020
c	0.10	0.18	0.26	0.004	0.007	0.010
D	2.90	3.00	3.10	0.114	0.118	0.122
E	1.30	1.50	1.70	0.051	0.059	0.067
e	0.85	0.95	1.05	0.034	0.037	0.041
L	0.20	0.40	0.60	0.008	0.016	0.024
HE	2.50	2.75	3.00	0.099	0.108	0.118
θ	0°	-	10°	0°	-	10°

#### STYLE 21:

- PIN 1: COLLECTOR 1  
 2. EMITTER 2  
 3. BASE 2  
 4. COLLECTOR 2  
 5. EMITTER 1  
 6. BASE 1

### SOLDERING FOOTPRINT\*

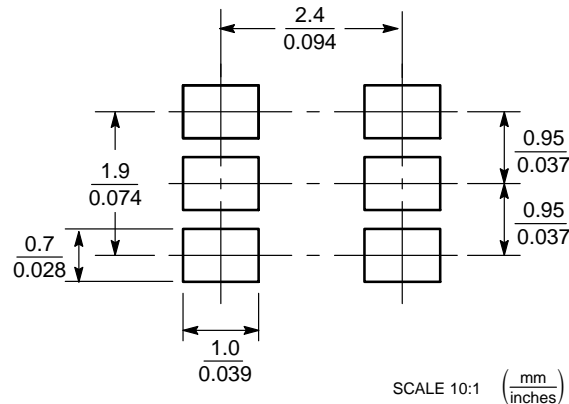

\*For additional information on our Pb-Free strategy and soldering details, please download the ON Semiconductor Soldering and Mounting Techniques Reference Manual, SOLDERRM/D.

ON Semiconductor and are registered trademarks of Semiconductor Components Industries, LLC (SCILLC). SCILLC reserves the right to make changes without further notice to any products herein. SCILLC makes no warranty, representation or guarantee regarding the suitability of its products for any particular purpose, nor does SCILLC assume any liability arising out of the application or use of any product or circuit, and specifically disclaims any and all liability, including without limitation special, consequential or incidental damages. "Typical" parameters which may be provided in SCILLC data sheets and/or specifications can and do vary in different applications and actual performance may vary over time. All operating parameters, including "Typicals" must be validated for each customer application by customer's technical experts. SCILLC does not convey any license under its patent rights nor the rights of others. SCILLC products are not designed, intended, or authorized for use as components in systems intended for surgical implant into the body, or other applications intended to support or sustain life, or for any other application in which the failure of the SCILLC product could create a situation where personal injury or death may occur. Should Buyer purchase or use SCILLC products for any such unintended or unauthorized application, Buyer shall indemnify and hold SCILLC and its officers, employees, subsidiaries, affiliates, and distributors harmless against all claims, costs, damages, and expenses, and reasonable attorney fees arising out of, directly or indirectly, any claim of personal injury or death associated with such unintended or unauthorized use, even if such claim alleges that SCILLC was negligent regarding the design or manufacture of the part. SCILLC is an Equal Opportunity/Affirmative Action Employer. This literature is subject to all applicable copyright laws and is not for resale in any manner.

### PUBLICATION ORDERING INFORMATION

**LITERATURE FULFILLMENT:**  
 Literature Distribution Center for ON Semiconductor  
 P.O. Box 5163, Denver, Colorado 80217 USA  
**Phone:** 303-675-2175 or 800-344-3860 Toll Free USA/Canada  
**Fax:** 303-675-2176 or 800-344-3867 Toll Free USA/Canada  
**Email:** orderlit@onsemi.com

**N. American Technical Support:** 800-282-9855 Toll Free  
 USA/Canada  
**Europe, Middle East and Africa Technical Support:**  
 Phone: 421 33 790 2910  
**Japan Customer Focus Center**  
 Phone: 81-3-5817-1050

**ON Semiconductor Website:** [www.onsemi.com](http://www.onsemi.com)  
**Order Literature:** <http://www.onsemi.com/orderlit>

For additional information, please contact your local Sales Representative